

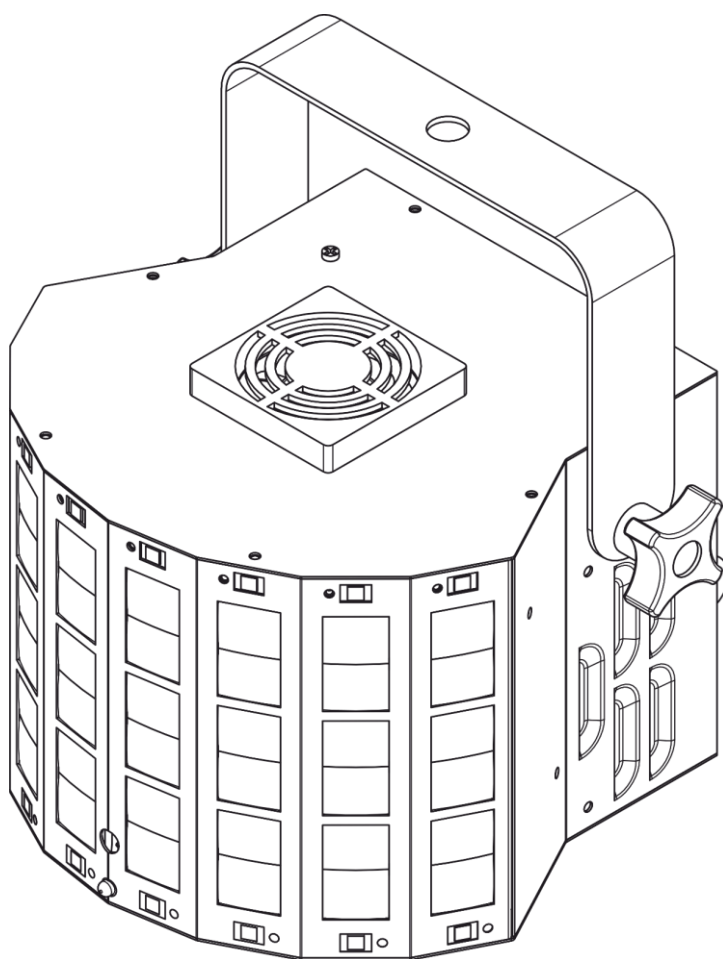

USER MANUAL



ENGLISH

Energetic XL

V1

Product code: 43169

Preface

Thank you for purchasing this Showtec product.

The purpose of this user manual is to provide instructions for the correct and safe use of this product.

Keep the user manual for future reference as it is an integral part of the product. The user manual shall be stored at an easily accessible location.

This user manual contains information concerning:

- Safety instructions
- Intended and non-intended use of the device
- Installation and operation of the device
- Maintenance procedures
- Troubleshooting
- Transport, storage and disposal of the device

Non-observance of the instructions in this user manual may result in serious injuries and damage of property.

©2021 Showtec. All rights reserved.

No part of this document may be copied, published or otherwise reproduced without the prior written consent of Highlite International.

Design and product specifications are subject to change without prior notice.

For the latest version of this document, please visit our website www.highlite.com or contact us at service@highlite.com.

Highlite International and its authorized service providers are not liable for any injury, damage, direct or indirect loss, consequential or economic loss or any other loss arising from the use of, or inability to use or reliance on the information contained in this document.

Table of contents

1. Introduction.....	4
1.1. Before Using the Product	4
1.2. Intended Use	4
1.3. Product Lifespan.....	4
1.4. Text Conventions	4
1.5. Symbols and Signal Words.....	5
1.6. Labels.....	5
2. Safety	6
2.1. Warnings and Safety Instructions	6
2.2. Requirements for the User.....	8
2.3. Laser Safety	9
2.4. Safety Devices	9
2.5. Personal Protective Equipment	9
3. Description of the Device	10
3.1. Front View	10
3.2. Back View	11
3.3. Product Specifications	12
3.4. Dimensions.....	13
4. Installation	14
4.1. Safety Instructions for Installation	14
4.2. Personal Protective Equipment	15
4.3. Installation Site Requirements	15
4.4. Rigging	15
4.4.1. Angle Adjustment.....	16
4.5. Connecting to Power Supply.....	16
5. Setup	17
5.1. Warnings and Precautions	17
5.2. Stand-alone Setup	17
5.3. DMX Connection.....	17
5.3.1. DMX-512 Protocol.....	17
5.3.2. DMX Cables.....	18
5.3.3. Master/Slave Setup	19
5.3.4. DMX Linking.....	20
5.3.5. DMX Addressing.....	20
6. Operation	21
6.1. Safety Instructions for Operation.....	21
6.2. Control Modes	21
6.3. Starting the Device	22
6.4. Menu Overview	23
6.5. Main Menu Options	24
6.6. Control Panel Operation	24
6.6.1. Auto Run Programs.....	25
6.6.2. Music Mode	25
6.6.3. Color Mode.....	25
6.6.4. DMX Mode / DMX Channels	27
6.6.5. Slave Mode.....	27
6.6.6. System Settings.....	27
6.7. Remote Control Operation	29
6.7.1. Show Mode.....	30
6.7.2. Music Mode	30
6.8. DMX Channels	31
7. Troubleshooting	33

- 8. Maintenance34**
 - 8.1. Safety Instructions for Maintenance34
 - 8.2. Preventive Maintenance34
 - 8.2.1. Basic Cleaning Instructions34
 - 8.3. Corrective Maintenance35
 - 8.3.1. Replacing the Fuse.....35
- 9. Deinstallation, Transportation and Storage36**
 - 9.1. Instructions for Deinstallation.....36
 - 9.2. Instructions for Transportation36
 - 9.3. Storage36
- 10. Disposal36**
- 11. Approval.....36**

1. Introduction

1.1. Before Using the Product



Important

Read and follow the instructions in this user manual before installing, operating or servicing this product.

The manufacturer will not accept liability for any resulting damages caused by the non-observance of this manual.

After unpacking, check the contents of the box. If any parts are missing or damaged, contact your Highlite International dealer.

Your shipment includes:

- Showtec Energetic XL
- IEC power cable (1,5 m)
- 2 keys for the interlock
- 2 keys for key switch
- Remote control plug
- IR remote control
- User manual

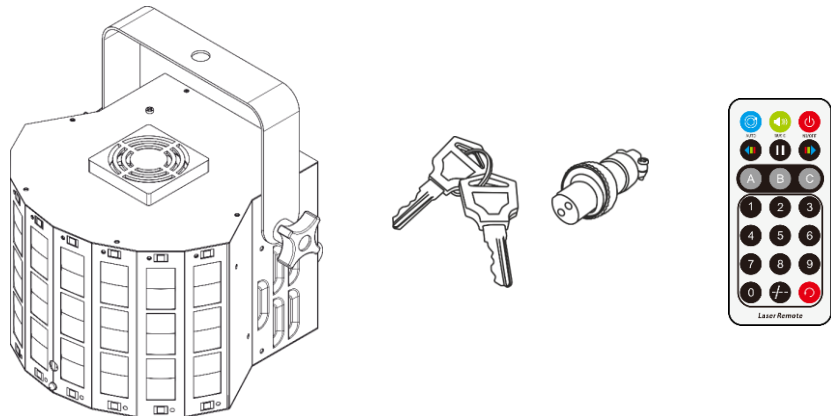

Fig. 01

1.2. Intended Use

This device is intended for professional use as a laser projector to produce laser displays or show effects. It is suitable only for indoor installation. This device is not suitable for households.

Any other use, not mentioned under intended use, is regarded as non-intended and incorrect use.

1.3. Product Lifespan

This device is not designed for permanent operation. Disconnect the device from the electrical power supply when the device is not in operation. This will reduce the wear and will improve the device's lifespan.

1.4. Text Conventions









Throughout the user manual the following text conventions are used:

- Buttons: All buttons are in bold lettering, for example "Press the **UP/DOWN** buttons"
- References: References to chapters and parts of the device are in bold lettering, for example: "Refer to **2. Safety**", "turn the **adjustment screw (02)**"
- 0–255: Defines a range of values
- Notes: **Note:** (in bold lettering) is followed by useful information or tips

1.5. Symbols and Signal Words

Safety notes and warnings are indicated throughout the user manual by safety signs.

Always follow the instructions provided in this user manual.

- 
DANGER Indicates an imminently hazardous situation which, if not avoided, will result in death or serious injury.
- 
WARNING Indicates a potentially hazardous situation which, if not avoided, could result in death or serious injury.
- 
CAUTION Indicates a potentially hazardous situation, which, if not avoided, may result in minor or moderate injury.
- 
Attention Indicates important information for the correct operation and use of the product.
- 
Attention Indicates that eye protection must be used.
- 
Important Read and observe the instructions in this document.
- 
Electrical hazard
- 
Laser beam hazard
- 
 Provides important information about the disposal of this product.

1.6. Labels

This device is a class 3B laser device and is provided with the following labels and hazard warnings. Refer to Fig. 02 for the position of the labels.



1	CAUTION - CLASS 3B LASER RADIATION WHEN OPEN, AVOID EXPOSURE TO BEAM	CAUTION - Class 3B laser radiation when open, Avoid exposure to beam	
2	LASER RADIATION AVOID DIRECT EYE EXPOSURE CLASS 3R LASER PRODUCT	Laser Radiation Avoid direct eye exposure Class 3R laser product	
3	 <div style="border: 2px solid black; padding: 2px; display: inline-block;">LASER APERTURE</div>	Avoid exposure – laser radiation is emitted from this aperture	

Fig. 02

2. Safety

**Important**

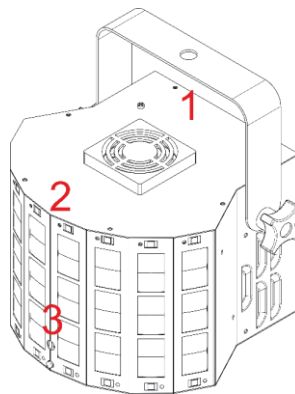
Read and follow the instructions in this user manual before installing, operating or servicing this product.

The manufacturer will not accept liability for any resulting damages caused by the non-observance of this manual.

2.1. Warnings and Safety Instructions

**DANGER**

Danger for children

For adult use only. The device must be installed beyond the reach of children.

- Do not leave various parts of the packaging (plastic bags, polystyrene foam, nails, etc.) within children's reach. Packaging material is a potential source of danger for children.

**DANGER**

Electric shock caused by dangerous voltage inside

There are areas within the device where dangerous touch voltage may be present.

- Do not open the device or remove any covers.
- Do not operate the device if the covers or the housing is open. Before operation, check if the housing is firmly closed and all screws are tightly fastened.
- Disconnect the device from electrical power supply before service and maintenance, and when the device is not in use.

**DANGER**

Electric shock caused by short-circuit

This device falls under IEC protection class I.

- Make sure that the device is electrically connected to ground (earth). Connect the device only to a socket-outlet with ground (earth) connection.
- Do not cover the ground (earth) connection.
- Do not bypass the thermostatic switch or fuses.
- For replacement use fuses of the same type and rating only.
- Do not let the power cable come into contact with other cables. Handle the power cable and all connections with the mains with caution.
- Do not modify, bend, mechanically strain, put pressure on, pull or heat up the power cable.
- Make sure that the power cable is not crimped or damaged. Examine the power cable periodically for any defects.
- Do not immerse the device in water or other liquids. Do not install the device in a location where flooding may occur.
- Do not use the device during thunderstorms. Disconnect the device from the electrical power supply immediately.



WARNING
Laser radiation
Avoid exposure to beam.

This device is a class 3R laser device according to the classification in NEN-EN-IEC 60825-1:2014. It emits visible radiation in the wavelength range 400–700 nm. Accidental exposure to the direct or reflected laser beam presents a low risk. Deliberate exposure to the direct or reflected laser beam can cause eye injury.

Check all applicable national and international regulations concerning laser safety before using this device. The user is responsible for the safety of all persons present during the use of the laser device.

- Do not look at the laser beam.
- Do not open the device and do not modify the device.
- Do not use the device if the housing or the optics are damaged.
- Do not point the laser beam at people or animals.
- Make sure that the beam is terminated on non-reflective and non-combustible surface.



Attention
Power supply

- Before connecting the device to the power supply, make sure that the current, voltage and frequency match the input voltage, current and frequency specified on the information label on the device.
- Make sure that the cross-sectional area of the extension cords and power cables is sufficient for the required power consumption of the device.



Attention
General safety

- Do not insert objects into the air vents.
- Do not connect the device to a dimmer pack.
- Do not switch the device on and off in short intervals. This decreases the device's life.
- Do not shake the device. Avoid brute force when installing or operating the device.
- If the device is dropped or struck, disconnect the device from the electrical power supply immediately.
- If the device is exposed to extreme temperature variations (e.g. after transportation), do not switch it on immediately. Let the device reach room temperature before switching it on, otherwise it may be damaged by the formed condensation.
- If the device fails to work properly, discontinue the use immediately.



Attention
For professional use only
This device shall be used only for the purposes it is designed for.

This device is designed to be used as a professional laser projector. Any incorrect use may lead to hazardous situations and result in injuries and material damage.

- This device is not suitable for households.
- This device is not designed for permanent operation.
- This device does not contain user-serviceable parts. Unauthorized modifications to the device will render the warranty void. Such modifications may result in injuries and material damage.

**Attention**

Before each use, examine the device visually for any defects.

Make sure that:

- All screws used for installing the device or parts of the device are tightly fastened and are not corroded.
- The safety devices are not damaged.
- There are no deformations on housings, fixations and installation points.
- The lens is not cracked or damaged.
- The power cables are not damaged and do not show any material fatigue.

**Attention**

Do not expose the device to conditions that exceed the rated IP class conditions.

This device is IP20 rated. IP (Ingress Protection) 20 class provides protection against solid objects greater than 12 mm, such as fingers, and no protection against harmful ingress of water.

2.2. Requirements for the User

This product may be used only by instructed or skilled persons. Installation and maintenance can be carried out by instructed or skilled persons. Service shall be carried out only by skilled persons. Contact your Highlite International dealer for more information.

This product may not be used by ordinary persons. Users, operators and installers should have received sufficient training in laser safety to be able to accurately assure that the MPE is not exceeded in spectator occupied areas and that the required separations are maintained between spectators and projections that exceed the MPE.

Instructed persons have been instructed and trained by a skilled person, or are supervised by a skilled person, for specific tasks and work activities associated with the operation, installation, service and maintenance of this product, so that they can identify risks and take precautions to avoid them.

Skilled persons have training or experience, which enables them to recognize risks and to avoid hazards associated with the operation, installation, service and maintenance of this product.

Ordinary persons are all persons other than instructed persons and skilled persons.

2.3. Laser Safety

**CAUTION**

Use of controls or adjustments, or performance of procedures, other than those specified in this manual, may result in hazardous radiation exposure.

Check all applicable national and international regulations concerning laser safety before using this device. In some countries, there may be specific requirements, such as government permissions or notifications of shows, or prohibitions, such as against laser scanning of spectators without appropriate safeguards.

Laser displays and shows, where class 3B and/or class 4 lasers are used, should be supervised by a laser safety officer (LSO). LSOs are trained to evaluate and control laser hazards and are responsible for overseeing the control of laser hazards. An LSO is recommended but not required for laser displays and shows, where only class 1, 1M, 2, 2M and/or 3R lasers are used.

During laser displays and shows the applicable eye and skin maximum permissible exposure (MPE) may not be exceeded. Under no circumstance should any person be exposed to laser radiation exceeding the applicable eye and skin MPE. MPE for spectators, ancillary personnel and performers is specified in IEC 60825-14, IEC 60825-3, and in the applicable local laser regulations.

Each time before operation of the device, make sure that:

- The beam is aligned and properly terminated
- All controls, including scan failure safeguards and emergency stop controls, are properly working
- Warning signs and barriers are in place as appropriate
- All components are securely mounted and locked into position

The device should be secured and protected against misalignment or maladjustment between alignment completion and the beginning of the laser display or show.

2.4. Safety Devices

This device is equipped with a key switch and a remote interlock connector. The key switch prevents that unauthorized and untrained persons can operate the device. If the key is removed, you cannot operate the device.

The remote interlock connector permits the connection of a remote interlock (not supplied). When you press the remote interlock, the laser radiation is terminated immediately. We recommend that you purchase a remote interlock. Check the local regulations, as in some countries it is not allowed to operate the device without a remote interlock.

For testing and programming purposes you may use the supplied test connector. If the test connector is not inserted into the remote interlock connector, you cannot operate the device.

2.5. Personal Protective Equipment

**Attention**

Use laser protective eyewear during alignment and setup.

Wearing of laser protective eyewear is recommended for Class 3B lasers. Make sure you follow any applicable national and site-specific regulations.

During alignment and setup use protective eyewear that complies with the requirements of EN 208. In all other cases laser protective eyewear must be in compliance with EN 207.

3. Description of the Device

The Showtec Energetic XL is a powerful and multifunctional lighting effect offering 3 effect in just one compact housing. The Showtec Energetic XL is equipped with a 30W COB RGBW which in combination with the dedicated optics creates 48 powerful beams. Two rows of 8 RGB LEDs on the top and bottom of the fixture create stunning matrix effect. Last but not least the red and green laser with 8 different grating effects create a variety of cool laser effect. The Showtec Energetic is the right solution for a wide range of applications. It is delivered with a remote control.

3.1. Front View

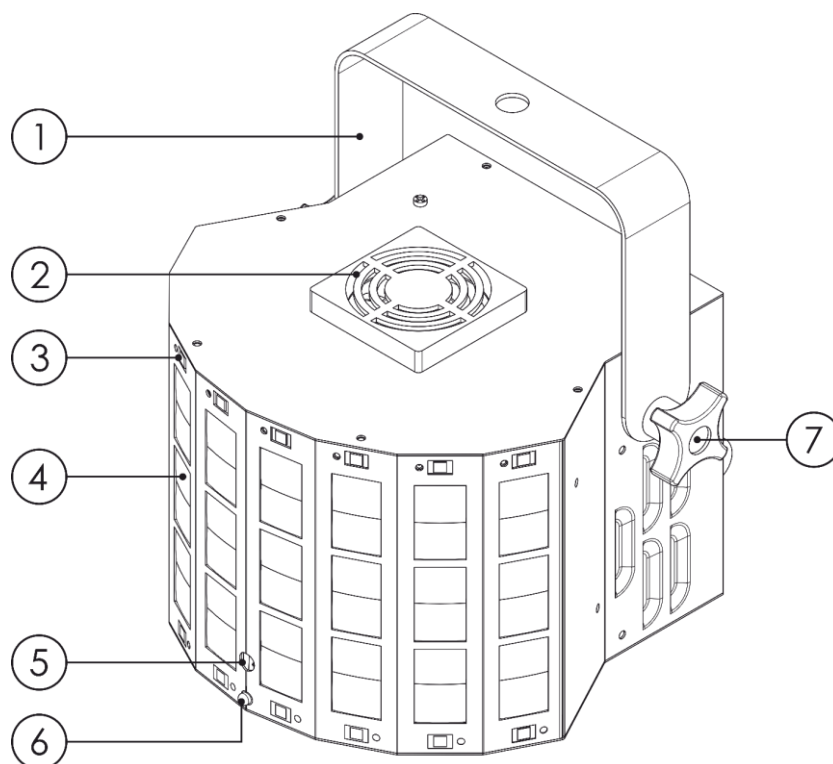

Fig. 03

- 01) Mounting bracket
- 02) Cooling Fan
- 03) 2x 8 RGB LEDs
- 04) 48 Beams
- 05) Laser beam aperture
- 06) Infrared sensor
- 07) Adjustment screw

3.2. Back View

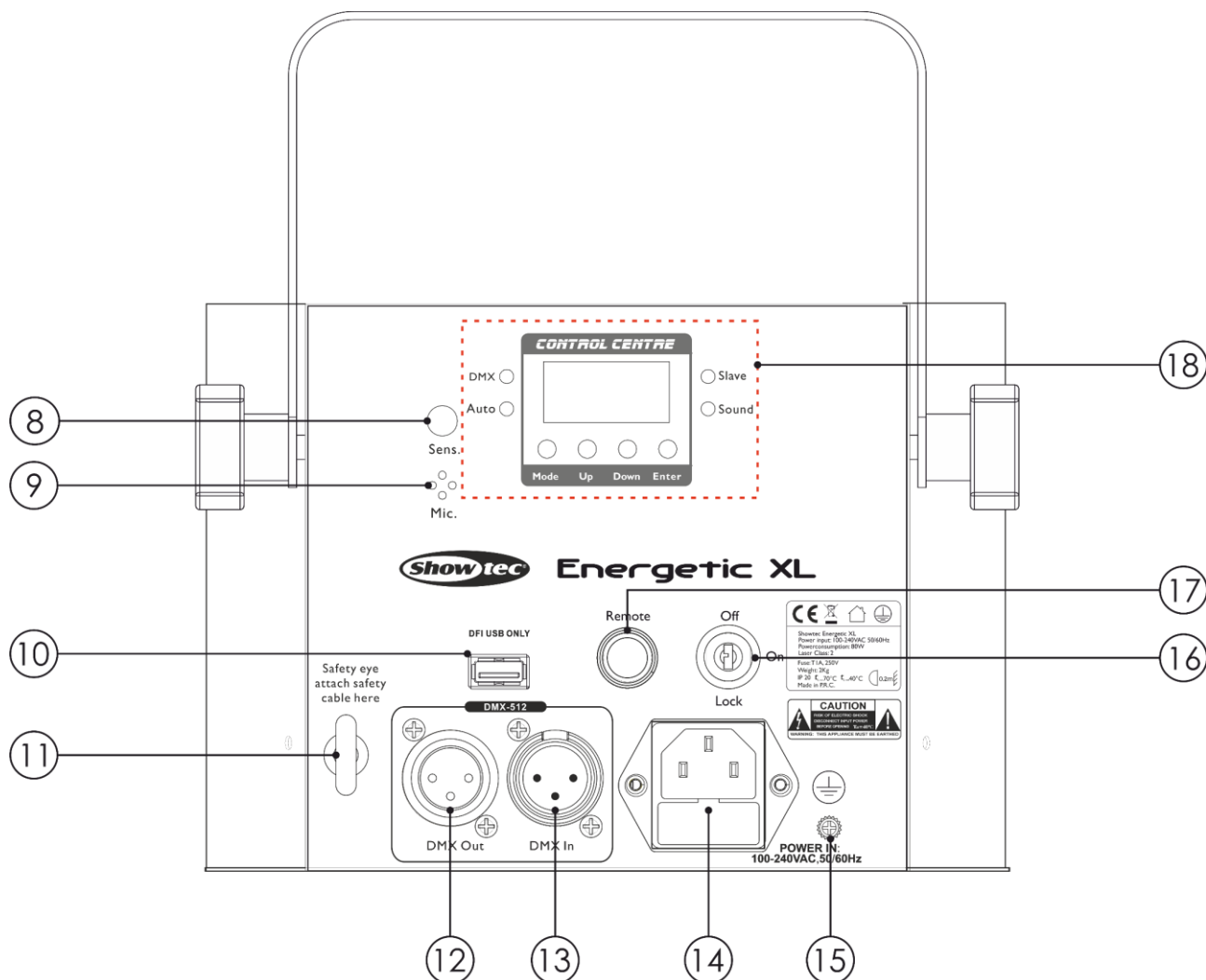

Fig. 04

- 08) Sound sensitivity control
- 09) Built-in microphone
- 10) USB Port for future software updates
- 11) Safety eye
- 12) 3-pin DMX connector OUT
- 13) 3-pin DMX connector IN
- 14) IEC (C14) power connector IN, 100–240 V + Fuse T1,6 A, 250 V
- 15) Ground (earth) connection
- 16) Key switch
- 17) Remote interlock connector
- 18) Control panel: 4-digit LED display, control buttons and LED indicators

3.3. Product Specifications

Model:	Energetic XL
Electrical:	
Input voltage:	100–240 V AC, 50/60 Hz
Power consumption:	80 W
Fuse:	Fuse T1,6 A, 250 V
Physical:	
Dimensions:	230 x 205 x 215mm (L x W x H) (with bracket)
Weight:	1,96 kg
Laser:	
Laser class:	3B
Laser power:	650 nm = 100 mW (red) 532 nm = 50 mW (green)
Beam divergence:	2 mrad
Operation and control:	
Control:	Stand-alone (auto, manual, sound-controlled) Master/Slave (auto, manual, sound-controlled) DMX-512
DMX channels:	2 and 9 channels
Control panel:	4-digit LED display, control buttons and LED indicators
Connections:	
Power connections:	IEC (C14) power connector IN, 100–240 V
Data connections:	3-pin DMX connectors IN/OUT
Signal pinouts:	pin 1 (ground), pin 2 (-), pin 3 (+)
Construction:	
Housing:	Metal
Color:	Black
IP rating:	IP20
Cooling:	Cooling fan
Thermal:	
Maximum ambient temperature t_a :	40 °C
Minimum ambient temperature:	-10 °C
Maximum housing temperature t_c :	50 °C

3.4. Dimensions

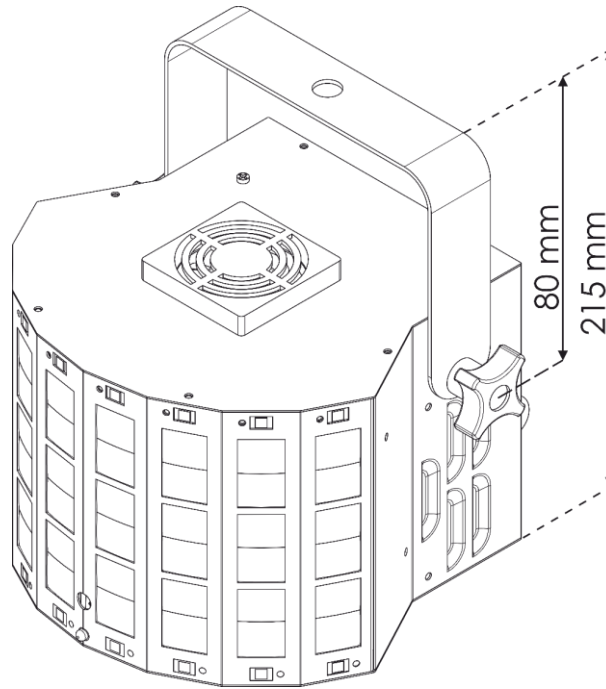

Fig. 05

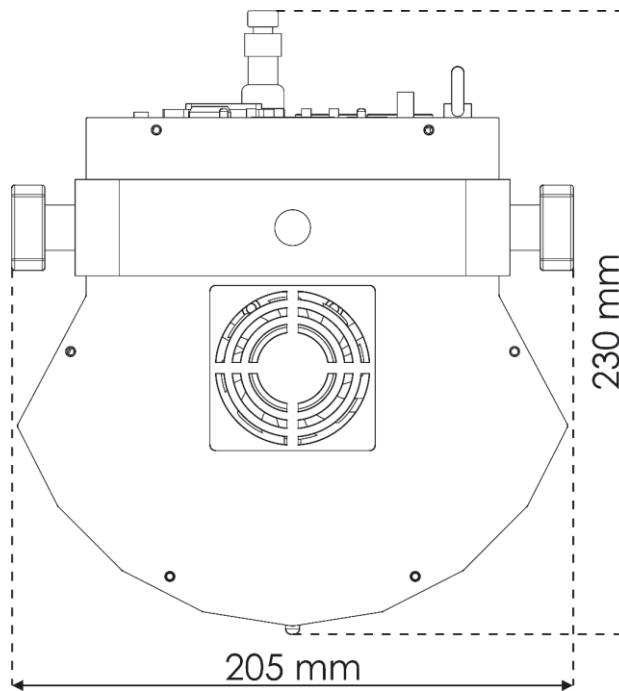

Fig. 06

4. Installation

4.1. Safety Instructions for Installation



WARNING

Incorrect installation can cause serious injuries and damage of property.

If trussing systems are used, installation must be carried out only by instructed or skilled persons.

- Make sure that the device is rigidly mounted to prevent movement due to vibration or jarring.
- Follow all applicable European, national and local safety regulations concerning rigging and trussing.

The device should be installed in such a way that there is at least 3 m distance in height and 2,5 m laterally between the laser beam that exceeds the spectator MPE and the surface where spectators are expected to stand.

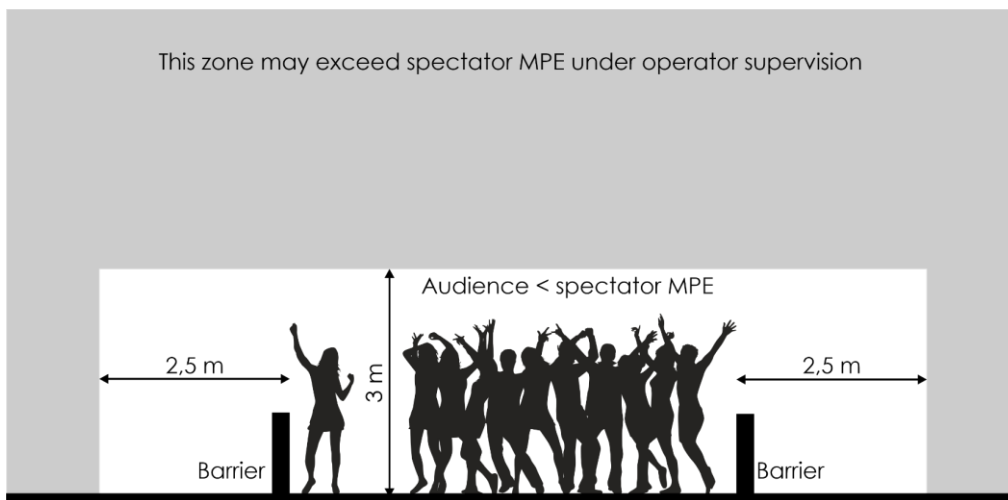

Fig. 07

If the laser display or show is not under the continuous control of an operator who can immediately terminate laser radiation in the event of a problem, the MPE shall not exceed 5 times the spectator MPE in the space between 3 m and 6 m above the surface where spectators are expected to stand.

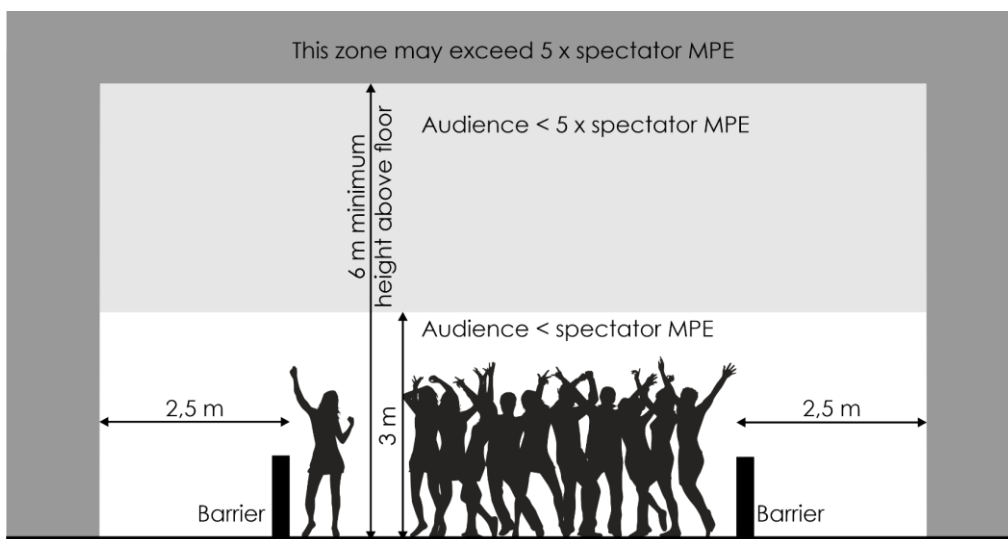

Fig. 08

4.2. Personal Protective Equipment

During installation and rigging wear personal protective equipment in compliance with the national and site-specific regulations.

4.3. Installation Site Requirements

- The device can be used only indoors.
- The minimum distance to other objects must be bigger than 0,5 m.
- The maximum ambient temperature $t_a = 40\text{ °C}$ must never be exceeded.
- The relative humidity must not exceed 50 % with an ambient temperature of 40 °C.

4.4. Rigging

The device can be positioned on a flat surface or mounted to a truss or other rigging structure. Make sure that all loads are within the pre-determined limits of the supporting structure.



CAUTION

Restrict the access under the work area during rigging and/or derigging.

To mount the device, follow the steps below:

- 01) Use a clamp to attach the device to the supporting structure, as shown in Fig. 09. Make sure that the device cannot move freely.
- 02) Secure the device with a secondary suspension, for example a safety cable. Make sure that the secondary suspension can hold 10 times the weight of the device. If possible, the secondary suspension should be attached to a supporting structure independent of the primary suspension. Put the safety cable through the **safety eye (11)**, as shown in Fig. 09.

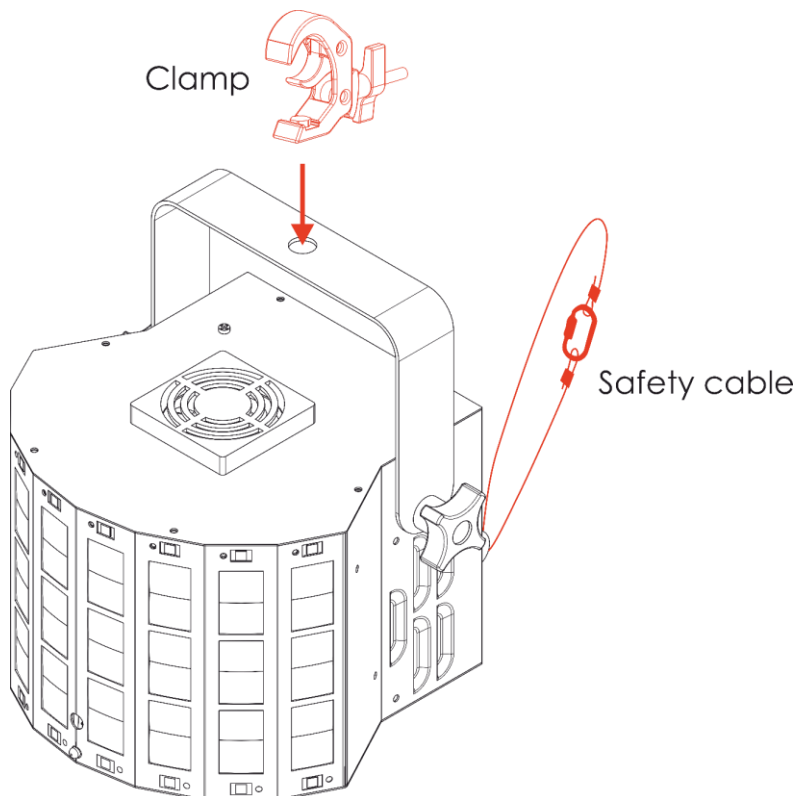

Fig. 09

4.4.1. Angle Adjustment

You can adjust the angle of the device with the **adjustment screws (06)**.

- 01) Turn the **adjustment screws (07)** counterclockwise to release them.
- 02) Tilt the device at the desired angle (see Fig. 10).
- 03) Turn the **adjustment screws (07)** clockwise to tighten them. Make sure that the device cannot move freely after the **adjustment screws (07)** are tightened.

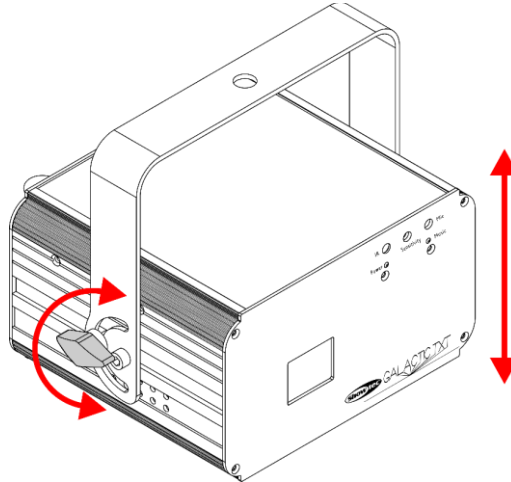

Fig. 10

4.5. Connecting to Power Supply



DANGER
Electric shock caused by short-circuit

The device accepts AC mains power at 100–240 V and 50/60 Hz. Do not supply power at any other voltage or frequency to the device.

This device falls under IEC protection class I. Make sure that the device is always electrically connected to the ground (earth).

Before connecting the device to the socket-outlet:

- Make sure that the power supply matches the input voltage specified on the information label on the device.
- Make sure that the socket-outlet has ground (earth) connection.

Connect the device to the socket-outlet with the power plug. Do not connect the device to a dimmer circuit, as this may damage the device.

5. Setup

5.1. Warnings and Precautions



WARNING
Laser radiation
Avoid exposure to beam.



Attention
Use laser protective eyewear during alignment and setup.

During alignment and setup the access of unauthorized persons to the area, where the laser radiation exceeds the spectator MPE, must be restricted. The temporary laser controlled area must be marked accordingly.

Follow all applicable national and site-specific regulations regarding laser safety.

5.2. Stand-alone Setup

When the Energetic XL is not connected to a controller or to other devices, it functions as a stand-alone device. It can be operated manually with the control panel, the keyboard, or the remote control.

5.3. DMX Connection



Attention
Connect all data cables before supplying power.
Disconnect power supply before connecting or disconnecting data cables.

5.3.1. DMX-512 Protocol

You need a DMX serial data link to run light shows of one or more devices using a DMX-512 controller or to run synchronized shows of two or more devices set in a master/slave operating mode.

The Energetic XL has 3-pin DMX signal IN and OUT connectors.

The pin assignment is as follows:

- 3-pin: pin 1 (ground), pin 2 (-), pin 3 (+)

Devices on a serial data link must be daisy-chained in a single line. The number of devices that you can control on one data link is limited by the combined number of the DMX channels of the connected devices and the 512 channels available in one DMX universe.

To comply with the TIA-485 standard, no more than 32 devices should be connected on one data link. In order to connect more than 32 devices on one data link, you must use a DMX optically isolated splitter/booster, otherwise this may result in deterioration of the DMX signal.

Note:

- Maximum recommended DMX data link distance: 300 m
- Maximum recommended number of devices on a DMX data link: 32 devices

5.3.2. DMX Cables

Shielded twisted-pair cables with 3-pin/5-pin XLR connectors must be used for reliable DMX connection. You can purchase DMX cables directly from your Highlite International dealer or make your own cables.

If you use XLR audio cables for DMX data transmission, this may lead to signal degradation and unreliable operation of the DMX network.

When you make your own DMX cables, make sure that you connect the pins and wires correctly as shown in Fig. 11.

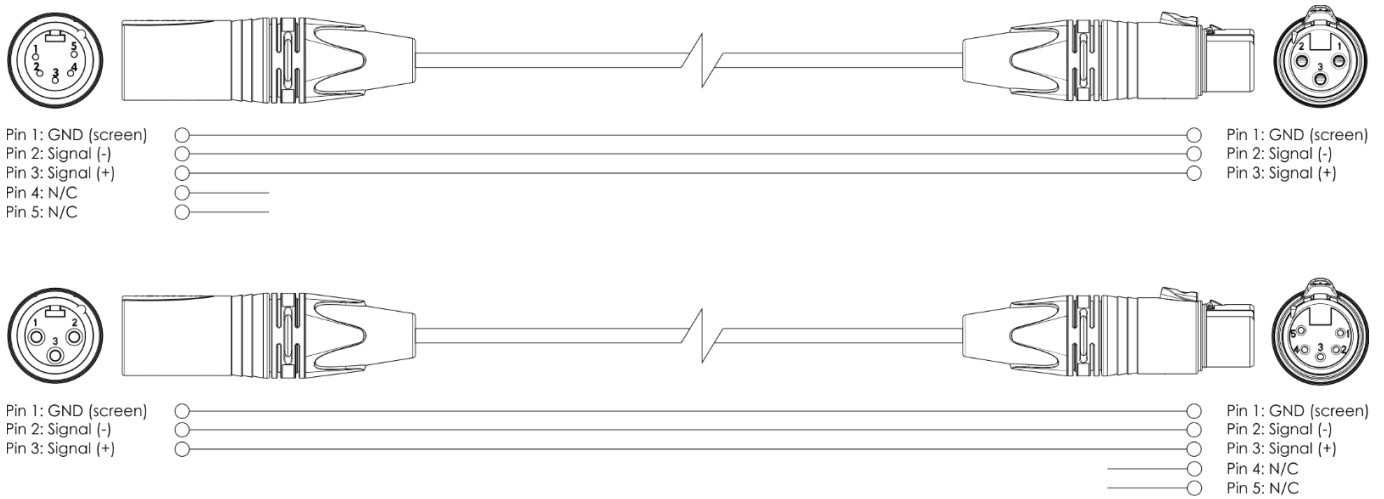

Fig. 11

5.3.3. Master/Slave Setup

The Energetic XL supports master/slave control mode. To connect multiple devices in a master/slave setup, follow the steps below:

- 01) Connect the first device's DMX OUT connector to the second device's DMX IN connector with a 3-pin DMX cable.
- 02) Repeat step 1 to connect all devices as shown in Fig. 12.
- 03) Connect a DMX terminator (120 Ω resistor) to the DMX OUT connector of the last device in the setup.
- 04) Set the first device on the data link as a master device. See **6.6.6. System Settings** on page 27 for more information.
- 05) Set the remaining devices as slave devices. See **6.6.5. Slave Mode** on page 27 for more information.

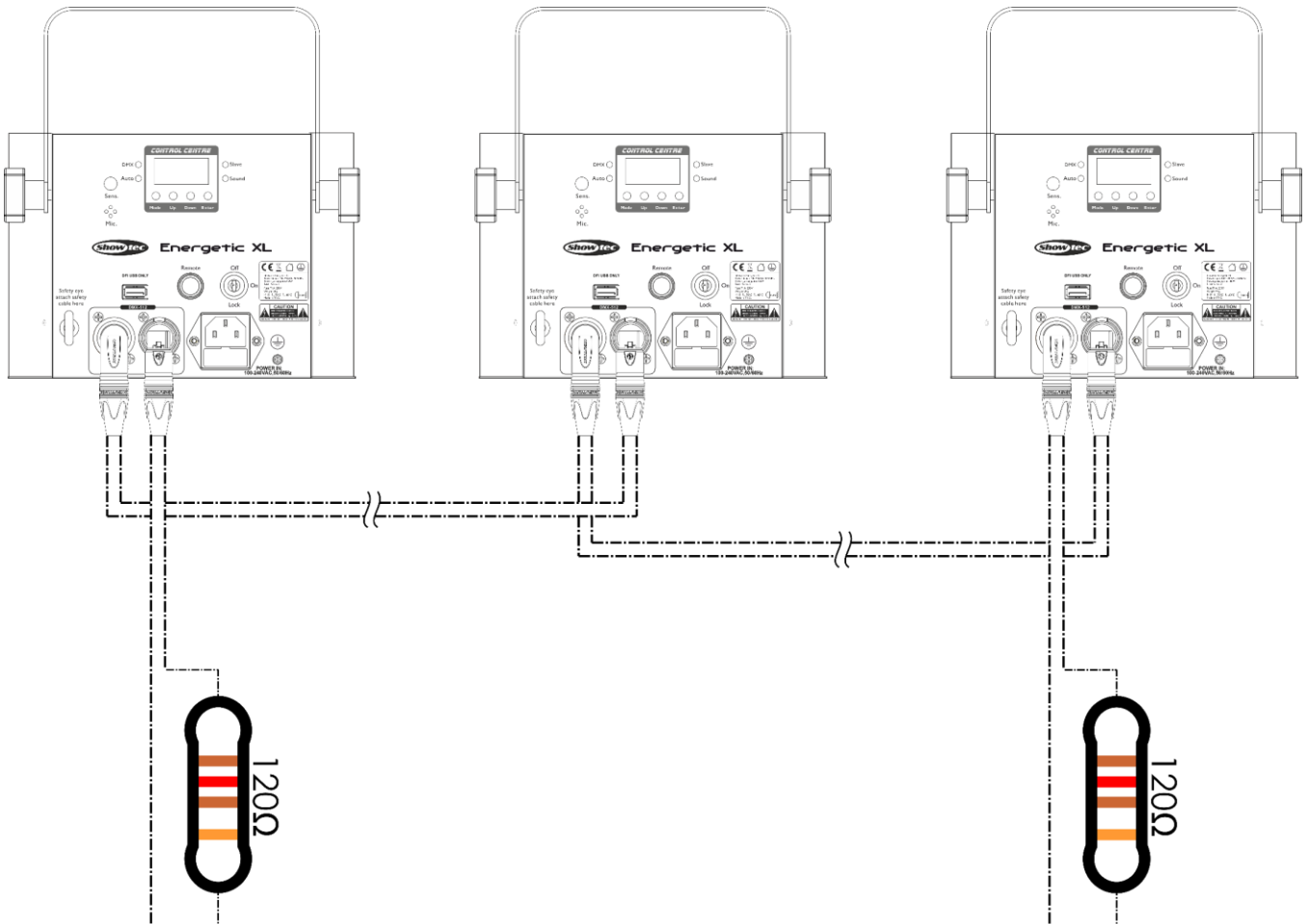

Fig. 12

5.3.4. DMX Linking

To connect multiple devices on one DMX data link, follow the steps below:

- 01) Use a 3-pin DMX cable to connect the DMX OUT connector of the lighting controller to the DMX IN connector of the first device.
- 02) Connect the first device's DMX OUT connector to the second device's DMX IN connector with a 3-pin DMX cable.
- 03) Repeat step 2 to connect all devices in a daisy-chain as shown in Fig. 13.
- 04) Connect a DMX terminator (120 Ω resistor) to the DMX OUT connector of the last device on the data link.

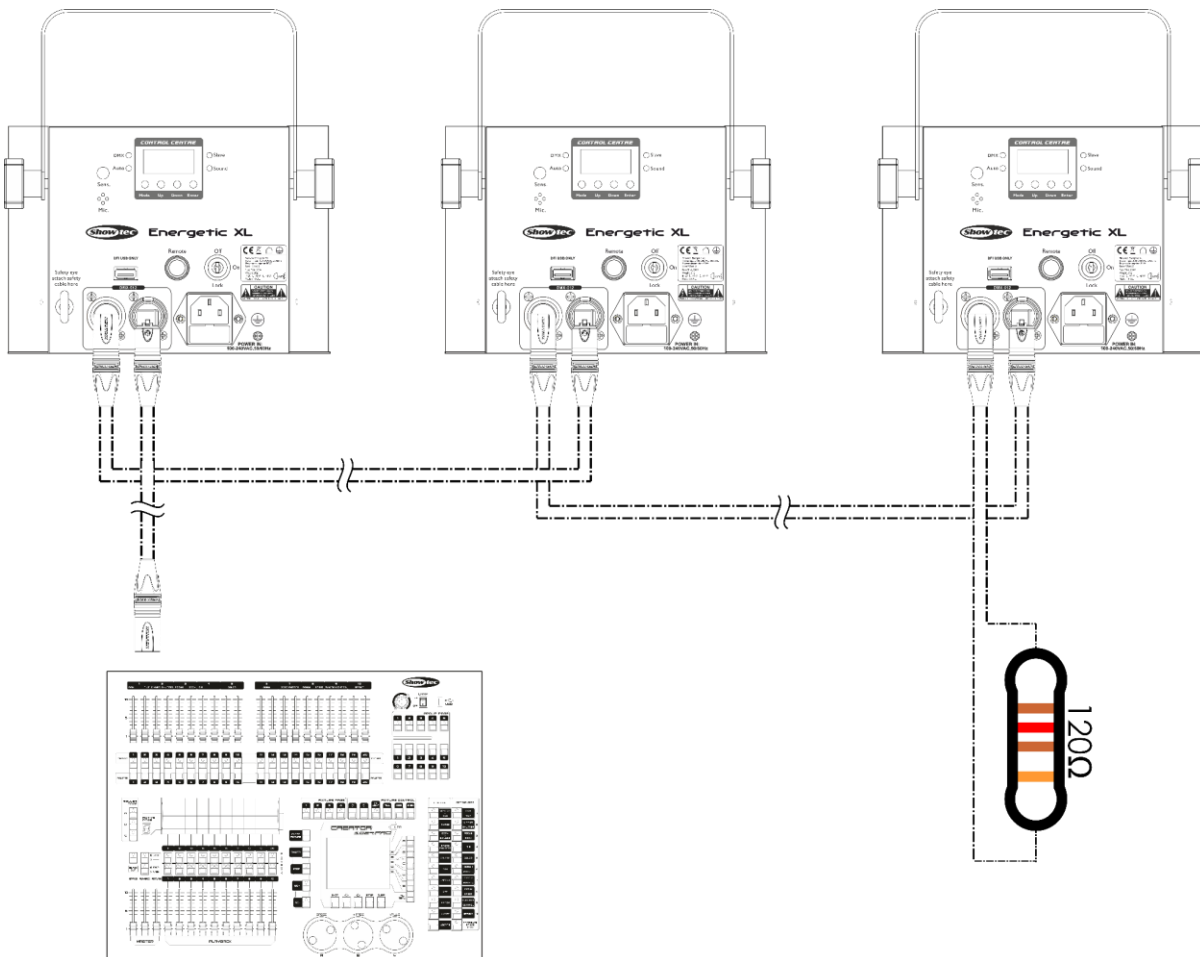

Fig. 13

5.3.5. DMX Addressing

In a setup with multiple devices, make sure that you set the DMX starting address of each device correctly. The Energetic XL has 2 personalities: 2 and 9 channels.

If you want to connect multiple devices on one data link, follow the steps below:

- 01) Set the starting address of the 1st device on the data link to 1 (001).
- 02) Set the starting address of the 2nd device on the data link to 10 (010), as $1 + 9 = 10$.
- 03) Set the starting address of the 3rd device on the data link to 19 (019), as $10 + 9 = 19$.
- 04) Continue assigning the starting addresses of the remaining devices by adding each time 9 to the previous number.

Make sure that you do not have any overlapping channels in order to control each Energetic XL correctly. If two or more devices are addressed similarly, they will work similarly.

6. Operation

The device can be operated with a DMX controller or manually.

Manual operation can be done using:

- the control panel
- the keyboard, or
- the remote control.

6.1. Safety Instructions for Operation



WARNING
Laser radiation
Avoid exposure to beam.

This device is a class 3B laser device according to the classification in NEN-EN-IEC 60825-1:2014. The device can be operated only by instructed or skilled persons.

- Check all applicable national and international regulations concerning laser safety before operating this device.



Attention
This device must be used only for the purposes it is designed for.

This device is intended for professional use as a laser projector to produce laser displays or show effects. It is suitable only for indoor installation. This device is not suitable for households.

Any other use, not mentioned under intended use, is regarded as non-intended and incorrect use.



Attention
Power supply

Before connecting the device to the power supply, make sure that the current, voltage and frequency match the input voltage, current and frequency specified on the information label on the device.

6.2. Control Modes

The Energetic XL supports the following control modes:

- Stand-alone: Auto mode (built-in shows), sound-controlled mode (built-in shows), manual mode
- Master/Slave: Auto mode (built-in shows), sound-controlled mode (built-in shows), manual mode
- DMX-512: 2 and 9 channels

6.3. Starting the Device

- 01) Make sure that all laser safety measures are in place and working. See **2.3. Laser Safety** on page 9 for more information.
- 02) Connect all data cables, if applicable. See **5.3. DMX Connection** on pages 17–20 for more information.
- 03) Connect the remote interlock (or emergency switch) to the **remote interlock connector (17)**. See **2.4. Safety Devices** on page 9 for more information. For programming purposes you may use the supplied test connector.

Note:

- If the test connector is not inserted into the remote interlock connector, you cannot operate the device. The device will power up, but it will not produce a laser beam.
 - The remote interlock is not supplied. You can purchase a remote interlock from your Highlite International dealer. Check your local regulations, as in some countries it is not allowed to operate the device without a remote interlock.
- 04) Connect the device to the socket-outlet with the power plug. See **4.5. Connecting to Power Supply** on page 16 for more information.
 - 05) The display shows a splash screen with the current version of the firmware:



- 06) Insert the key into the **key switch (16)**. The device is now operational. Turn the **key switch (16)** into ON position to turn on the laser beam. See **2.4. Safety Devices** on page 9 for more information.

6.4. Menu Overview

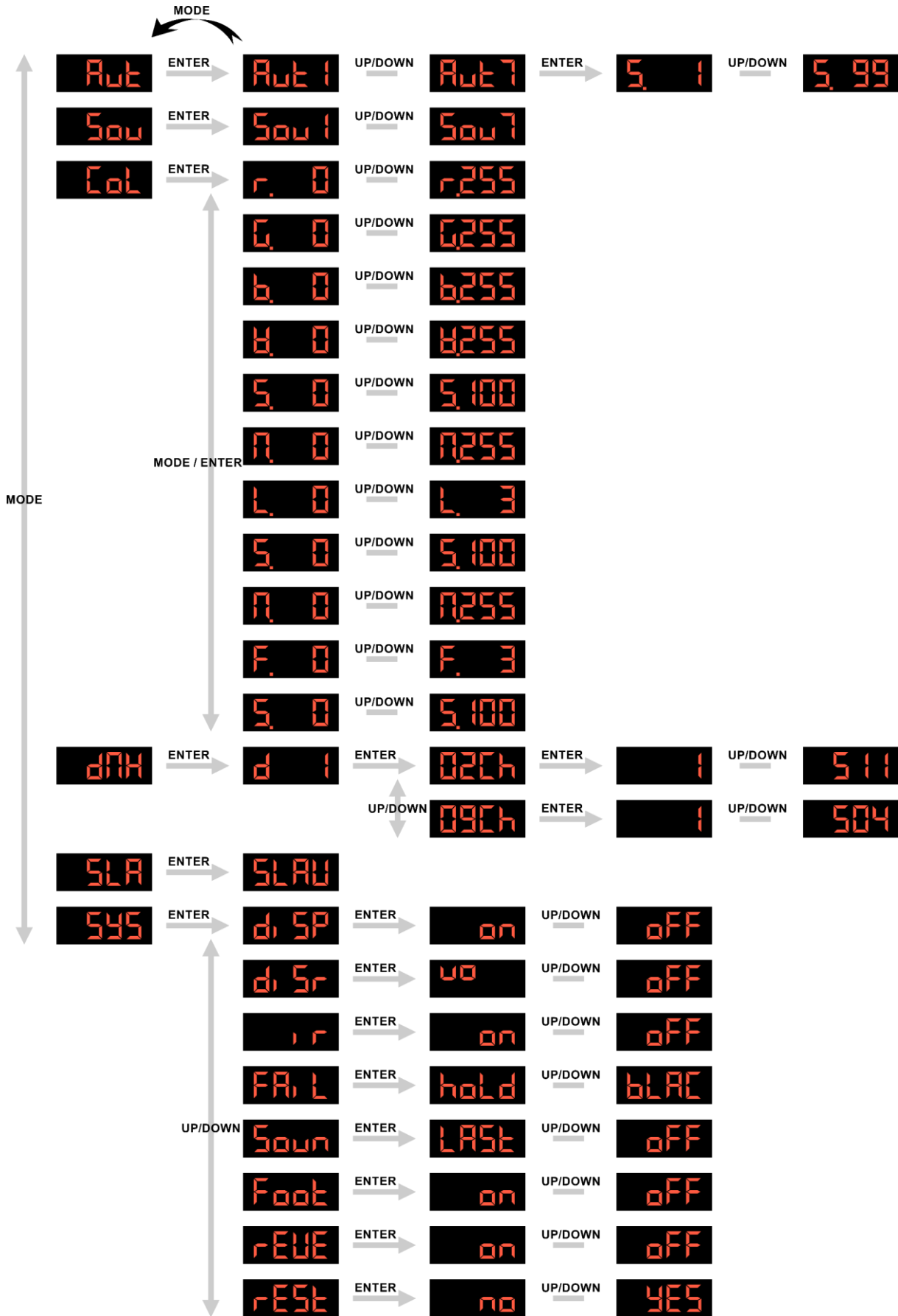

6.5. Main Menu Options

From the main menu you can access the following operating modes:

	1. Show mode
	2. Music mode
	3. Static Color Mode
	4. DMX mode
	5. Slave mode
	6. System settings

If the device is not connected to a DMX controller, you can operate the device using:

- the control panel
- the remote control.

6.6. Control Panel Operation

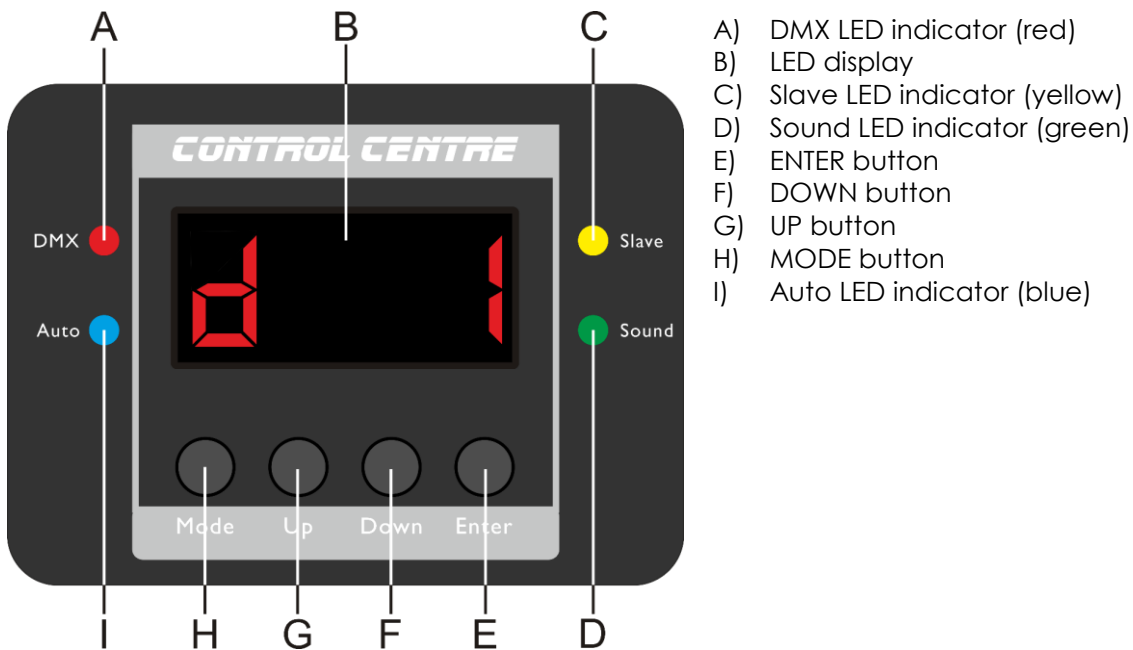

Fig. 14

- Use the **MENU** button to exit the current submenu, to return to the main menu and to navigate through the main menu.
- Use the **UP/DOWN** buttons to navigate through the menus or to increase/decrease numeric values.
- Use the **ENTER** button to open the desired menu, to confirm your choice or to set the currently selected value.

6.6.1. Auto Run Programs

In this menu you can play the built-in programs. You can additionally adjust the speed.



- 01) Press the **ENTER** button to enter show mode.
- 02) Press the **UP/DOWN** buttons to select one of the 7 built-in shows.
- 03) Press the **ENTER** button to enable the speed adjustment.
- 04) Press the **UP/DOWN** buttons to adjust the speed of the built-in program. The selection range is 01–99, from low to high speed.

6.6.2. Music Mode

In this menu you can activate sound-controlled mode.



- 01) Press the **ENTER** button to enter music mode.
- 02) Press the **UP/DOWN** buttons to select one of the 7 sound-controlled programs.
- 03) Press the **ENTER** button to confirm the selection. The device plays the show, reacting to the beat of music.

6.6.3. Color Mode



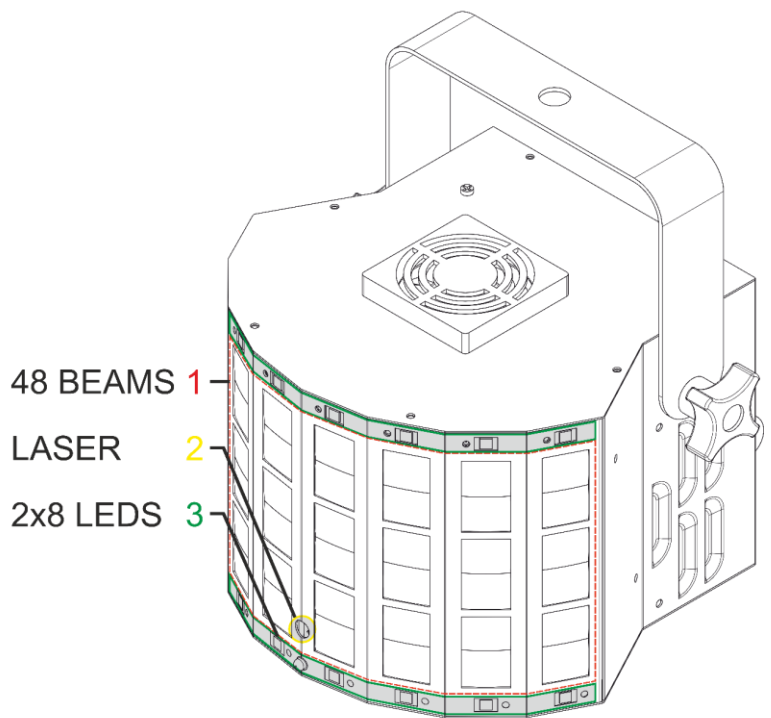
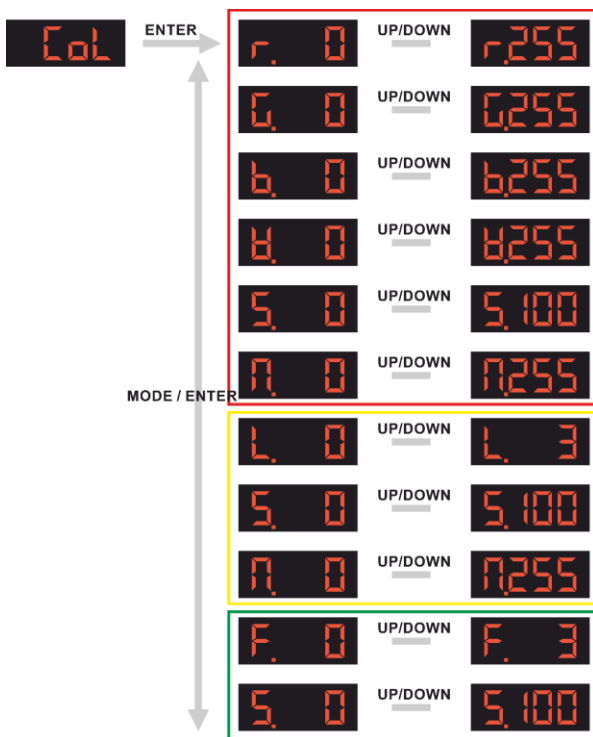







In this menu you can activate color mode.



In this menu you can manually adjust:

- The color and the intensity of the light output
- The rotations speed of the Wash Beams and the Laser
- The frequency of the strobe flash for the Wash Beams, the Laser and the LEDs.

- 01) Press the **MODE** button to navigate through the Main Menu until the display shows **Col**.
- 02) Press the **ENTER** button to open this menu.
- 03) Press repeatedly the **ENTER** button to navigate through the following options:

	Dimmer intensity of the Wash LEDs, RED from low to high (0-255)
	Dimmer intensity of the Wash LEDs, GREEN from low to high (0-255)
	Dimmer intensity of the Wash LEDs, BLUE from low to high (0-255)
	Dimmer intensity of the Wash LEDs, WHITE from low to high (0-255)
	Strobe of the Wash LEDs 000 OFF 001-098 from low to high frequency 099 full light output, no strobe 100 sound-controlled strobe
	Rotation of the Wash LEDs, from slow to fast
	Colors of the Laser L0 OFF L1 Red L2 Green L3 Red + Green
	Strobe of the Laser 000 OFF 001-098 from low to high frequency 099 full light output, no strobe 100 sound-controlled strobe
	Rotation of the Laser, from slow to fast
	Colors of the LEDS L0 OFF L1 Red L2 Green L3 Blue
	Strobe of the LEDS 000 OFF 001-098 from low to high frequency 099 full light output, no strobe 100 sound-controlled strobe

- 04) Press the **UP/DOWN** buttons to select the values.

6.6.4. DMX Mode / DMX Channels

In this menu you can enable DMX control mode and set the DMX starting address of the device.



01) Press the **ENTER** button to enable DMX control mode. The display shows the current DMX starting address. If there is no DMX connection, the display is blinking.

Note: If you exit DMX mode, the DMX connection will be discontinued and the device will not react to the DMX controller.

- 02) Press the **ENTER** button to enable the DMX Mode.
- 03) The device will show its current DMX address.
- 04) Press the **Enter** button again to open the submenu.
- 05) Press the **UP/DOWN** buttons to select your desired DMX Mode. You can choose 2 or 9 channels.
- 06) Choose the desired configuration and press the **Enter** button to open the submenu.
- 07) Press the **Up** and **Down** buttons to set the desired DMX address.
- 08) If you choose the **02Ch** configuration, the adjustment range is between **UP/DOWN** .
- 09) If you choose the **09Ch** configuration, the adjustment range is between **UP/DOWN** .

6.6.5. Slave Mode

In this menu you can set the device as a slave device in master/slave control mode.



Press the **ENTER** button to set the device as a slave device.

6.6.6. System Settings

With this menu you can set several system functions.

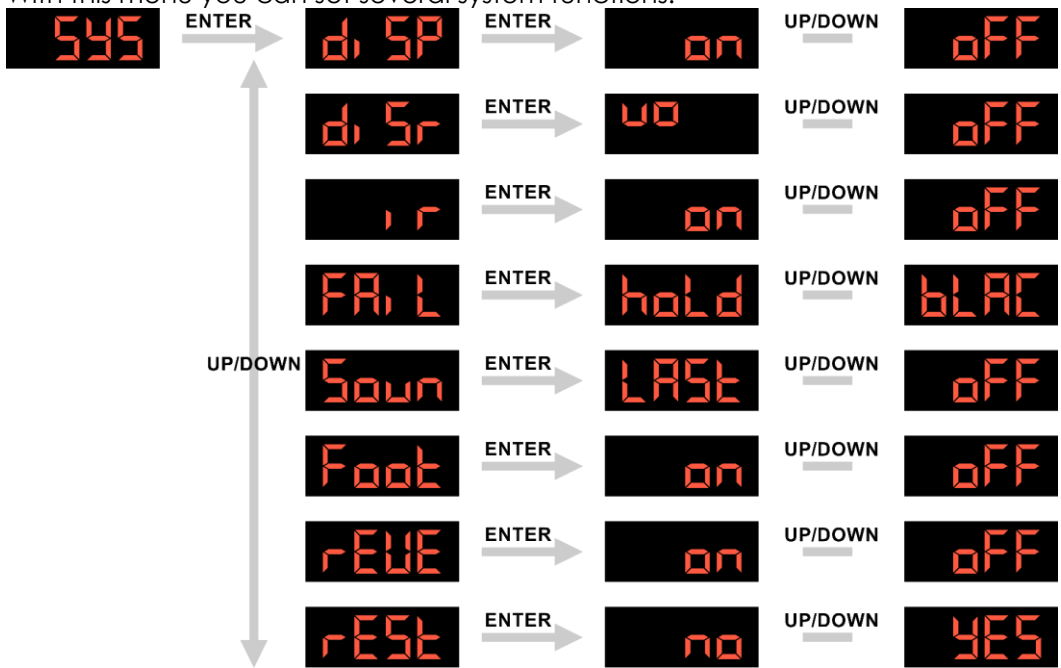

- 01) Press the **Menu** button until the display shows **545**.
- 02) Press the **Enter** button to open this menu.
- 03) Press the **Up** and **Down** buttons to choose between 8 settings:

d SP	LED display on/off
d Sr	LED display reverse
r	IR remote control on/off
FAiL	Reset to default settings
Sound	Sound controlled
Foot	No Function
rEUE	No Function
rESt	Reset to default settings

- 04) If you have chosen **d SP**, press the **Enter** button to set the LED display **ON** or **OFF**.
- 05) Press the **Up** and **Down** buttons to choose between **on** UP/DOWN **off**.
- 06) If you choose **off**, the display will continuously light up.
- 07) If you choose **on**, the display will turn off after 40 seconds, the display will show **---**.
- 08) If you have chosen **d Sr**, press the **Enter** button to set the display in reverse mode.
- 09) Press the **Up** and **Down** buttons to choose between **no** UP/DOWN **off**.
- 10) If you choose **off**, the display will be displayed normally.
- 11) If you choose **no**, the display will be displayed reversed.
- 12) If you have chosen **r**, press the **Enter** button to activate the IR mode.
- 13) If you choose **off** the included IR remote control will not work.
- 14) If you choose **on**, the included IR remote control will be activated.
- 15) If you have chosen **Sound**, press the **Enter** button to activate the sound-controlled mode.
- 16) If you choose **off** the sound-control will not work.
- 17) If you choose **on**, the sound-control will be activated.
- 18) If you choose **Foot** this function will not work.
- 19) If you choose **rEUE** this function will not work.
- 20) If you have chosen **rESt**, press the **Enter** button to reset to default settings.
- 21) Press the **Up** and **Down** buttons to choose between **no** UP/DOWN **yes**.
- 22) To reset the device choose **yes**.
- 23) Press the **Enter** button to confirm.
- 24) The display will show its version **U 100** and the device settings have been reset.
- 25) The device will start up in the Auto Run Programs mode.

6.7. Remote Control Operation

The device can be operated with an IR remote control. The remote control is included in the delivery.



DANGER
Do not ingest battery, chemical burn hazard.

The remote control contains a coin cell battery. If the coin cell battery is swallowed, it can cause severe internal burns in just 2 hours and can lead to death.

The battery is already installed in the remote control. It is protected against discharge by a transparent plastic foil. Remove the plastic foil before using the remote control for the first time.







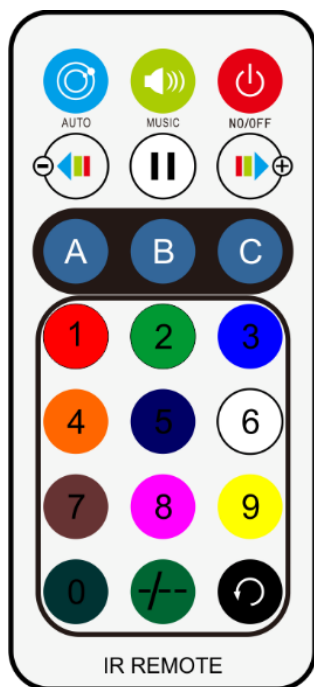

When replacing the battery, make sure that the polarity is correct. Incorrect polarity may damage the remote control.

To operate the device with the IR remote control:

- 01) Enable IR remote control operation in the system settings. See **6.6.6. System Settings** on page 27 for more information.
- 02) Point the remote control to the **infrared sensor (06)**.



Note: buttons  and  have no function.

Button	Function	Description
	On / Off	Press the ON/OFF button for 2 seconds to activate the different modes except the Slave mode.
	Auto program mode	Press the button to activate the Auto program.
	Sound-controlled mode	Press the button to activate the Music program. If the device receives a sound signal, the Music LED indicator on the backside will blink (Green LED).
	No Function	
	No Function	
	No Function	
	Pause	Press the button to pause the built-in programs or color change
	Speed	Press one of the buttons to adjust the built-in program speed. 0 = slowest, 9 = fastest
	Color settings	Press the buttons to choose the desired built-in LED color

- Press the **ON/OFF** button to turn on the laser beam.
- Press the **ON/OFF** button again to turn off the laser beam.

6.7.1. Show Mode

- 01) Press the **AUTO** button to enter show mode. The device plays back the built-in shows in random order.
- 02) Press the **AUTO** button repeatedly to select one of the 7 built-in shows.
- 03) Press the **PAUSE** button to pause the show. Press the **PAUSE** button again to resume the show.

6.7.2. Music Mode

- 01) Press the **SOUND** button to enter music mode.
- 02) Press the **SOUND** button repeatedly to select one of the 7 built-in shows.

6.8. DMX Channels

2 CH	9 CH	Function	Value	Setting
1	1	Built-in Programs	000-009	No function
			010-044	Par & Strobe & Laser
			045-079	Par & Strobe
			080-114	Par & Laser
			115-149	Strobe & Laser
			150-184	Par
			185-219	Strobe
			220-255	Laser
2	2	Speed / Sound (If CH1=010-255)	000-250	Speed adjustment, from slow to fast
			251-255	From low to high sensitivity
3	3	Static Colors (If CH1=000-009)	000-005	No function
			006-020	Red
			021-035	Green
			036-050	Blue
			051-065	White
			066-080	Red+Green
			081-095	Red+Blue
			096-110	Red+White
			111-125	Green+Blue
			126-140	Green+White
			141-155	Blue+White
			156-170	Red+Green+Blue
			171-185	Red+Green+White
			186-200	Green+Blue+White
			201-215	Red+Green+Blue+White
			216-230	4-color chase, from slow to fast
231-255	7-color chase, from slow to fast			
4	4	Strobe (If CH3=006-255)	000-005	No function
			006-020	Strobe
5	5	Motor Rotation	000	Not functional
			001-127	Shake effect, from slow to fast
			128-255	Motor indexing
6	6	Strobe Patterns	000-009	No function
			010-019	Pattern 1, from slow to fast
			020-029	Pattern 2, from slow to fast
			030-039	Pattern 3, from slow to fast
			040-049	Pattern 4, from slow to fast
			050-059	Pattern 5, from slow to fast
			060-069	Pattern 6, from slow to fast
			070-079	Pattern 7, from slow to fast
			080-089	Pattern 8, from slow to fast
			090-099	Pattern 9, from slow to fast
			100-109	Pattern 10, from slow to fast
			110-119	Pattern 11, from slow to fast
			120-129	Pattern 12, from slow to fast
			130-139	Pattern 13, from slow to fast
			140-149	Pattern 14, from slow to fast
			150-159	Pattern 15, from slow to fast
			160-169	Pattern 16, from slow to fast
			170-179	Pattern 17, from slow to fast
180-189	Pattern 18, from slow to fast			

2 CH	9 CH	Function	Value	Setting
			190-199	Pattern 19, from slow to fast
			200-209	Pattern 20, from slow to fast
			210-219	Pattern 21, from slow to fast
			220-229	Pattern 22, from slow to fast
			230-239	Pattern 23, from slow to fast
			240-249	Pattern 24, from slow to fast
			250-255	Pattern 25, from slow to fast
	7	Laser Colors (If CH1=000-009)	000-009	No function
			010-049	Red laser on
			050-089	Green laser on
			090-129	Red + Green laser on
			130-169	Red laser on + Green laser flashes
			170-209	Red laser flashes + Green laser on
			210-255	First Red laser flash, then Green laser flash
	8	Strobe Laser (If CH7=010-255)	000-009	Not functional
			010-254	Strobe flash frequency, from low to high frequency
			255	Sound-activated strobe
	9	Laser Rotation (If CH7=010-255)	000-004	No function
			005	Clockwise rotation, fast
			006-127	Clockwise rotation, from slow to fast
			128-133	Stop
			134-255	Counter clockwise rotation, from slow to fast

Note:

- The Speed / Sound Channel works only in combination when CH1 is set between 010-255.
- The Static Colors Channel works only in combination when CH1 is set between 000-009.
- The Strobe Channel works only in combination when CH3 is set between 006-255.
- The Laser Colors Channel works only in combination when CH8 is set between 010-255.
- The Strobe Laser Channel must be set between 10-255 for the strobe or sound control of CH7 to work.
- The Laser Rotation Channel works only in combination when CH7 is set between 010-255.

7. Troubleshooting

This troubleshooting guide contains actions which can be carried out by the user. The device does not contain user-serviceable parts.

Unauthorized modifications to the device will render the warranty void. Such modifications may result in injuries and material damage.

Refer servicing to instructed or skilled persons. Contact your Highlite International dealer in case the solution is not described in the table.

Problem	Probable cause(s)	Solution
The device does not power up	No power to the device	<ul style="list-style-type: none"> Check if power is switched on and cables are plugged in
	Main fuse is blown	<ul style="list-style-type: none"> Replace the fuse. See 8.3.1. Replacing the Fuse on page 35
The device does not produce a laser projection	The key switch is not in ON position	<ul style="list-style-type: none"> Insert the key switch and turn it in ON position. See 2.4. Safety Devices on page 9
	The remote interlock or the test connector is not connected	<ul style="list-style-type: none"> Connect the remote interlock or the test connector. See 2.4. Safety Devices on page 9
The device responds erratically	The factory settings of the device are changed	<ul style="list-style-type: none"> Reset the device's parameters to the default factory settings. See 6.6.6. System Settings on page 27
The device does not respond to DMX control	The controller is not connected	<ul style="list-style-type: none"> Connect the controller
	The device is not in DMX mode	<ul style="list-style-type: none"> Activate DMX mode from the main menu
	The signal is reversed. The 3-pin/5-pin DMX OUT of the controller does not match the DMX IN of the device	<ul style="list-style-type: none"> Install a phase-reversing cable between the controller and the device
	The controller is defective	<ul style="list-style-type: none"> Try using another controller
The device responds erratically to DMX control	Bad data link connection	<ul style="list-style-type: none"> Examine connections and cables. Correct poor connections. Repair or replace damaged cables
	The data link is not terminated with a 120 Ω termination plug	<ul style="list-style-type: none"> Insert a termination plug in the DMX OUT connector of the last device on the link
	Incorrect addressing	<ul style="list-style-type: none"> Check address settings and correct, if necessary
	In case of a setup with multiple devices, one of the devices is defective and disturbs data transmission on the link	<ul style="list-style-type: none"> To find out which is the defective device, bypass one device at a time until normal operation is restored
The device does not respond to IR remote control	The IR remote control is not enabled	<ul style="list-style-type: none"> Enable the IR remote control from the main menu
	The IR sensor is out of range	<ul style="list-style-type: none"> Try using the remote control from a different angle.
	The battery of the remote control is depleted	<ul style="list-style-type: none"> Change the battery

8. Maintenance

8.1. Safety Instructions for Maintenance



DANGER
Electric shock caused by dangerous voltage inside

Disconnect power supply before servicing or cleaning.



WARNING
Laser radiation
Avoid exposure to beam.

This device is a class 3B laser device according to the classification in NEN-EN-IEC 60825-1:2014.

Maintenance can be carried out by instructed or skilled persons. Service shall be carried out only by skilled persons. Contact your Highlite International dealer for more information.

8.2. Preventive Maintenance



Attention
Before each use, examine the device visually for any defects.

Make sure that:

- All screws used for installing the device or parts of the device are tightly fastened and are not corroded.
- The safety devices are not damaged.
- There are no deformations on housings, fixations and installation points.
- The lens is not cracked or damaged.
- The power cables are not damaged and do not show any material fatigue.

8.2.1. Basic Cleaning Instructions



WARNING
Laser radiation
Avoid exposure to beam

To avoid laser emission, remove the key before cleaning the device.

The external lens of the device must be cleaned periodically in order to optimize the laser output. The cleaning schedule depends on the conditions at the site where the device is installed. When smoke or fog machines are used at the site, the device will need more frequent cleaning. On the other hand, if the device is installed in well-ventilated area, it will need less frequent cleaning. To establish a cleaning schedule, examine the device at regular intervals during the first 100 hours of operation.

To clean the device, follow the steps below:

- 01) Disconnect the device from the electrical power supply.
- 02) Allow the device to cool down for at least 15 minutes.
- 03) Remove the dust collected on the external surface with dry compressed air and a soft brush.
- 04) Clean the lens with a damp cloth. Use a mild detergent solution.

- 05) Dry the lens carefully with a lint-free cloth.
- 06) Clean the DMX and other connections with a damp cloth.



Attention

- Do not immerse the device in liquid.
- Do not use alcohol or solvents.
- Make sure that the connections are fully dry before connecting the device to the power supply and to other devices.

8.3. Corrective Maintenance

The device does not contain user-serviceable parts. Do not open the device and do not modify the device.

Refer repairs and servicing to skilled persons. Contact your Highlite International dealer for more information.

8.3.1. Replacing the Fuse



DANGER Electric shock caused by short-circuit

- Do not bypass the thermostatic switch or fuses.
- For replacement use fuses of the same type and rating only.

Power surges, short-circuit or incorrect electrical power supply may cause a fuse to burn out. If the fuse burns out, the device will not function anymore. If this happens, follow the steps below.

- 01) Disconnect the device from the electrical power supply.
- 02) Allow the device to cool down for at least 15 minutes.
- 03) Pry up the integrated fuse holder with a flat-blade screwdriver.
- 04) If the fuse is brown or unclear, it is burned out. Remove the old fuse.
- 05) Insert a new fuse in the fuse holder. Make sure that the type and the rating of the replacement fuse are the same as the ones specified on the information label of the product.
- 06) Replace the integrated fuse holder in the opening and push it gently back in its place.

9. Deinstallation, Transportation and Storage

9.1. Instructions for Deinstallation

**WARNING**

Incorrect deinstallation can cause serious injuries and damage of property.

- Let the device cool down before dismounting.
- Disconnect power supply before deinstallation.
- Always observe the national and site-specific regulations during deinstallation and derigging of the device.
- Wear personal protective equipment in compliance with the national and site-specific regulations.

9.2. Instructions for Transportation

- Use the original packaging to transport the device, if possible.
- Always observe the handling instructions printed on the outer carton box, for example: "Handle with care", "This side up", "Fragile".

9.3. Storage

- Clean the device before storing. Follow the cleaning instructions in chapter **8.2.1. Basic Cleaning Instructions** on page 34.
- Store the device in the original packaging, if possible.

10. Disposal

Correct disposal of this product



Waste Electrical and Electronic Equipment

This symbol on the product, its packaging or documents indicates that the product shall not be treated as household waste. Dispose of this product by handing it to the respective collection point for recycling of electrical and electronic equipment. This is to avoid environmental damage or personal injury due to uncontrolled waste disposal. For more detailed information about recycling of this product contact the local authorities or the authorized dealer.

11. Approval



Check the respective product page on the website of Highlite International (www.highlite.com) for an available declaration of conformity.

This product is in compliance with IEC60825-1:2014.



©2021 Showtec