

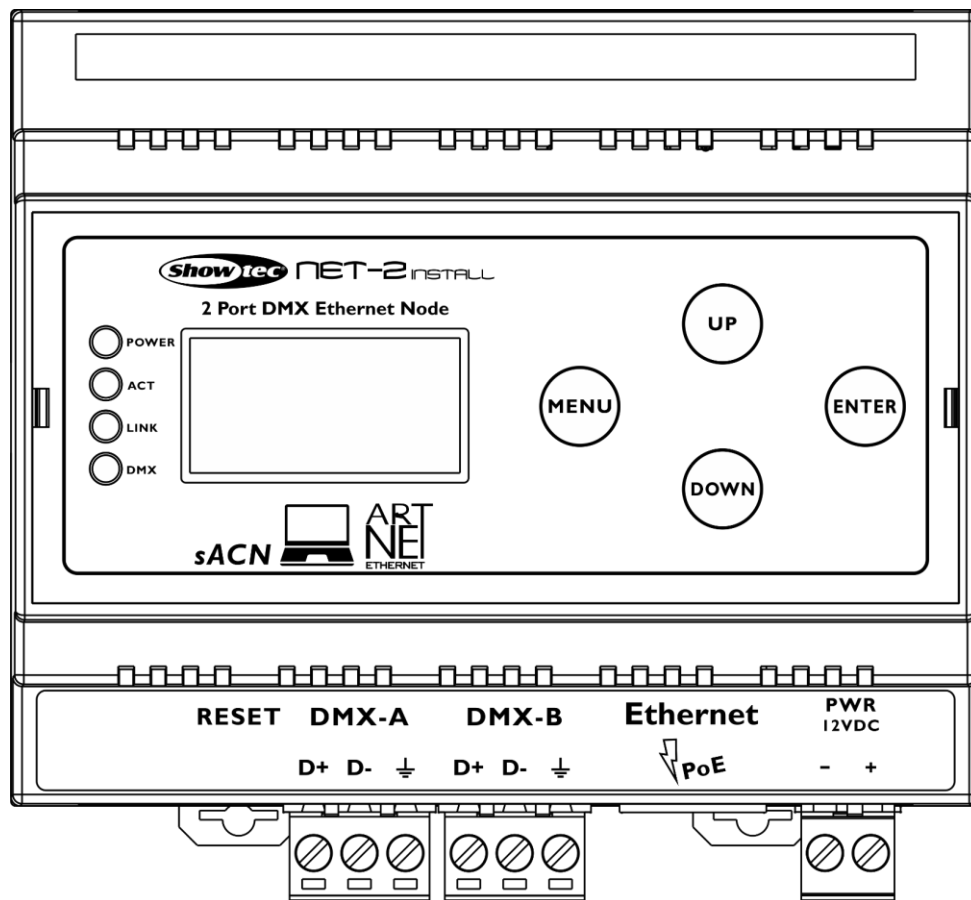

# MANUAL



ENGLISH

## Net-2 Install

V1

Order code: 50816

**Table of contents**

<b>Warning</b> .....	2
Safety Instructions .....	2
Operating Determinations .....	3
Connection with the mains.....	4
Return Procedure.....	4
Claims.....	4
<b>Description of the Device</b> .....	5
Overview .....	5
Front.....	6
<b>Installation</b> .....	6
<b>Setup and Operation</b> .....	7
Setup .....	7
Setup Net-2 Install with Laptop/PC .....	7
Setup Net-2 Install with Lighting Controller .....	8
Connecting to a Network .....	9
Art-Net Settings.....	9
sACN Settings.....	9
How to Make a Data Cable .....	9
Fixture Linking .....	10
Data Cabling .....	10
Operation .....	10
Control Panel.....	11
Status Menu .....	11
Menu Overview.....	12
Main Menu Options.....	13
1. Rename .....	13
2. IP Mode .....	13
2.1. DHCP IP.....	14
2.2. Manual IP .....	14
3. Set Netmask.....	14
4. Set DMX Port .....	15
5. Set Display .....	16
6. Set Default.....	16
7. Firmware Version.....	16
Settings Configuration via Web Browser .....	17
Changing the Password .....	18
Updating the Firmware .....	18
<b>Maintenance</b> .....	18
<b>Troubleshooting</b> .....	19
<b>Product Specifications</b> .....	20
<b>Dimensions</b> .....	21

## Warning



**For your own safety, please read this user manual carefully  
before your initial start-up!**



## Unpacking Instructions

Immediately upon receiving this product, carefully unpack the carton and check the contents to ensure that all parts are present, and have been received in good condition. Notify the dealer immediately and retain packing material for inspection if any parts appear damaged from shipping or the carton itself shows signs of mishandling. Save the carton and all packing materials. In the event that a fixture must be returned to the factory, it is important that the fixture be returned in the original factory box and packing.

## Your shipment includes:

- Showtec Net-2 Install
- User manual

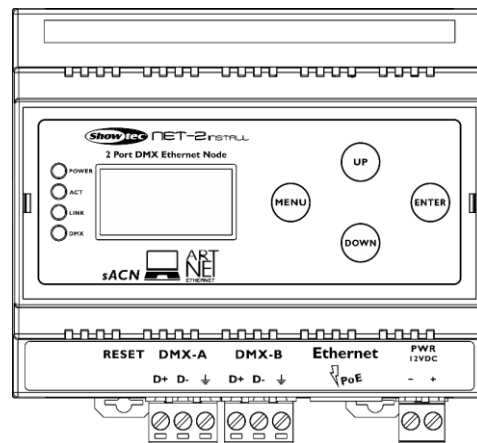

**CAUTION!**  
**Keep this device away from rain and moisture!**  
**Unplug mains lead before opening the housing!**



## Safety Instructions

Every person involved with the installation, operation and maintenance of this device has to:

- be qualified
- follow the instructions of this manual



**CAUTION! Be careful with your operations.**  
**With a dangerous voltage you can suffer  
a dangerous electric shock when touching the wires!**



Before your initial start-up, please make sure that there is no damage caused by transportation. Should there be any, consult your dealer and do not use the device.

To maintain perfect condition and to ensure a safe operation, it is absolutely necessary for the user to follow the safety instructions and warning notes written in this manual.

Please consider that damages caused by manual modifications to the device are not subject to warranty.

This device contains no user-serviceable parts. Refer servicing to qualified technicians only.

### IMPORTANT:

The manufacturer will not accept liability for any resulting damages caused by the non-observance of this manual or any unauthorized modification to the device.

- Never let the power cord come into contact with other cables! Handle the power cord and all connections with the mains with particular caution!
- Never remove warning or informative labels from the unit.
- Never leave any cables lying around.
- Do not connect this device to a dimmer pack.
- Do not switch the device on and off in short intervals, as this would reduce the device's life.
- Do not touch the device's housing bare-handed during its operation. Allow the fixture to cool for at least 5 minutes before handling.
- Do not shake the device. Avoid brute force when installing or operating the device.
- Only use device indoors, avoid contact with water or other liquids.
- Only operate the fixture after having checked that the housing is firmly closed and all screws are tightly fastened.
- Only operate the device after having familiarized yourself with its functions.
- Avoid flames and do not put close to flammable liquids or gases.
- Always keep case closed while operating.
- Always allow free air space of at least 50 cm around the unit for ventilation.
- Always disconnect power from the mains, when device is not used or before cleaning! Only handle the power cord by the plug. Never pull out the plug by tugging the power cord.
- Make sure that the device is not exposed to extreme heat, moisture or dust.
- Make sure that the available voltage is not higher than stated on the rear panel.
- Make sure that the power cord is never crimped or damaged. Check the device and the power cord from time to time.
- If device is dropped or struck, disconnect mains power supply immediately. Have a qualified engineer inspect for safety before operating.
- If the device has been exposed to drastic temperature fluctuation (e.g. after transportation), do not switch it on immediately. The arising condensation water might damage your device. Leave the device switched off until it has reached room temperature.
- If your Showtec device fails to work properly, discontinue use immediately. Pack the unit securely (preferably in the original packing material), and return it to your Showtec dealer for service.
- For adult use only. Device must be installed out of the reach of children. Never leave the unit running unattended.
- The user is responsible for correct positioning and operating of the Net-2 Install. The manufacturer will not accept liability for damages caused by the misuse or incorrect installation of this device.
- Repairs, servicing and electric connection must be carried out by a qualified technician.
- WARRANTY: Till one year after date of purchase.

### Operating Determinations

- This device is not designed for permanent operation. Consistent operation breaks will ensure that the device will serve you for a long time without defects.
- The maximum ambient temperature  $t_a = 40\text{ °C}$  must never be exceeded.
- In order to eliminate wear and improve the device's lifespan, during periods of non-use, completely disconnect from power source via breaker or by unplugging.
- The relative humidity must not exceed 50 % with an ambient temperature of  $40\text{ °C}$ .
- If this device is operated in any other way, than the one described in this manual, the product may suffer damages and the warranty becomes void.
- Any other operation may lead to dangers like short-circuit, burns, electric shock, crash etc.

*You endanger your own safety and the safety of others!*

*Improper installation can cause serious damage to people and property!*

## Connection with the mains

Connect the device to the mains with the supplied AC power adapter.  
Always pay attention, that the right color cable is connected to the right place.

International	EU Cable	UK Cable	US Cable	Pin
L	BROWN	RED	YELLOW/COPPER	PHASE
N	BLUE	BLACK	SILVER	NULL
	YELLOW/GREEN	GREEN	GREEN	EARTH

*Make sure that the device is always properly connected to the earth!*

*Improper installation can cause serious injuries and/or damage of property!*

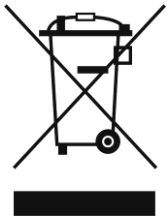

### **Return Procedure**

Returned merchandise must be sent prepaid and in the original packing, call tags will not be issued. Package must be clearly labeled with a Return Authorization Number (RMA number). Products returned without an RMA number will be refused. Highlite will not accept the returned goods or any responsibility. Call Highlite 0031-455667723 or mail [offersales@highlite.com](mailto:offersales@highlite.com) and request an RMA prior to shipping the fixture. Be prepared to provide the model number, serial number and a brief description of the cause for the return. Be sure to properly pack fixture, any shipping damage resulting from inadequate packaging is the customer's responsibility. Highlite reserves the right to use its own discretion to repair or replace product(s). As a suggestion, proper UPS packing or double-boxing is always a safe method to use.

**Note: If you are given an RMA number, please include the following information on a piece of paper inside the box:**

- 01) Your name
- 02) Your address
- 03) Your phone number
- 04) A brief description of the symptoms

### Claims

The client has the obligation to check the delivered goods immediately upon delivery for any shortcomings and/or visible defects, or perform this check after our announcement that the goods are at their disposal. Damage incurred in shipping is the responsibility of the shipper; therefore the damage must be reported to the carrier upon receipt of merchandise.

It is the customer's responsibility to notify and submit claims with the shipper in the event that a fixture is damaged due to shipping. Transportation damage has to be reported to us within one day after receipt of the delivery.

Any return shipment has to be made post-paid at all times. Return shipments must be accompanied with a letter defining the reason for return shipment. Non-prepaid return shipments will be refused, unless otherwise agreed in writing.

Complaints against us must be made known in writing or by fax within 10 working days after receipt of the invoice. After this period complaints will not be handled anymore.

Complaints will only then be considered if the client has so far complied with all parts of the agreement, regardless of the agreement of which the obligation is resulting.

## Description of the Device

### Features

The Showtec Net-2 Install is a cutting-edge network routing device which converts Art-Net or sACN to DMX-512 and vice versa. It is suitable for fixed installations. It allows for the transmission of a maximum of 1024 DMX channels over a single Ethernet cable. The Net-2 Install can be configured remotely via a web interface and can be powered using the Phoenix terminals or PoE (Power-over-Ethernet) technology. It supports Backup, Normal, Single, HTP and LTP merging options.

- Power supply: 12–36 V DC, 500 mA or PoE (802.3af)
- Power consumption: 6 W
- DMX: 2 universes (IN and/or OUT)
- Ethernet speed: 10/100Base-T
- Data connection: 3-pin Phoenix terminal (maximum cable gauge: 1,5 mm<sup>2</sup> / AWG: 12), RJ45
- Power connection: 2-pin Phoenix terminal (maximum cable gauge: 1,5 mm<sup>2</sup> / AWG: 12)
- Control modes: Art-Net, sACN, TCP/IPv4, DMX-512-A
- Setup: Control panel, web interface
- Merging options: HTP, LTP, Normal, Backup
- DMX data refresh rate: 40 Hz default (adjustable 10–40 Hz)
- Display: OLED
- Mounting: 35-mm DIN rail system (DIN EN43880 form factor; DIN EN60715 rail system)
- Mounting size: 6 TE
- Housing: UL94-V0 flame-retardant polycarbonate
- Color: Gray
- IP rating: IP20
- Operating temperature: 0–40 °C
- Dimensions: 105 x 98 x 58 mm (LxWxH)
- Weight: 0,18 kg

### Overview

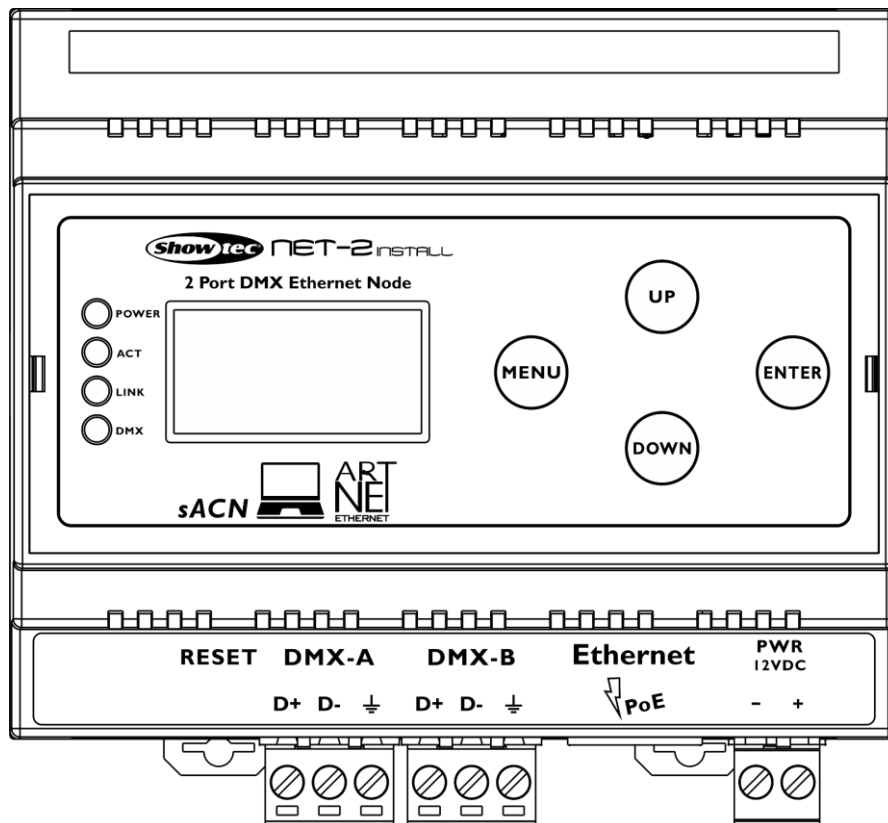

Fig. 01

## Front

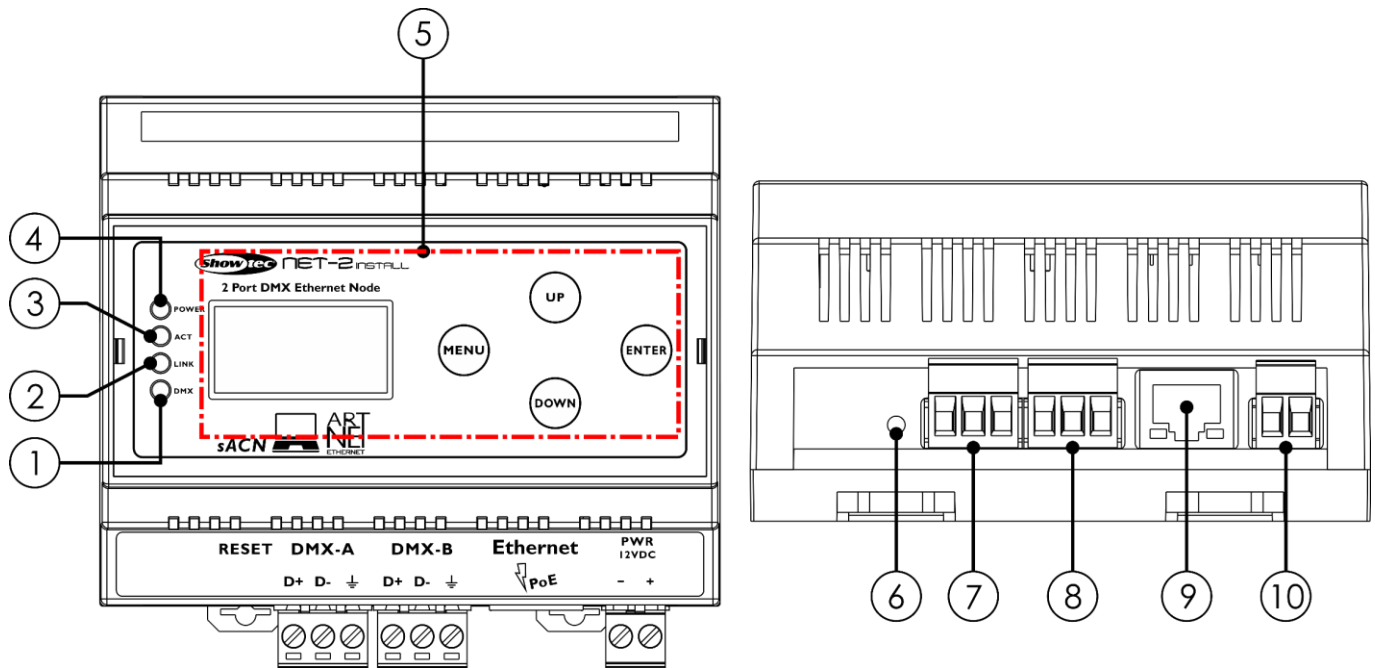

Fig. 02

- 01) DMX LED indicator  
This indicator lights up when there is DMX signal present on DMX ports A and B.
- 02) Link LED indicator  
This indicator lights up when a network signal is received.
- 03) Activity LED indicator  
This indicator lights up when there is network activity.
- 04) Power LED indicator  
This indicator lights up when the device is powered.
- 05) OLED display + control buttons
- 06) RESET button  
Press this button to reset the device to factory defaults. To reset the device via the control panel, see **6. Set Default** on page 16.
- 07) DMX port A, 3-pin Phoenix terminal connector IN/OUT
- 08) DMX port B, 3-pin Phoenix terminal connector IN/OUT
- 09) Ethernet RJ45 connector
- 10) 12–36 V DC 2-pin Phoenix terminal power connector IN

## Installation

Remove all packing materials from the Net-2 Install. Check that all foam and plastic padding is removed. Connect the Net-2 Install to a power outlet. Alternatively, the Net-2 Install can be powered from the Ethernet connection, using Power-over-Ethernet (PoE) technology. If the network switch does not support PoE, you can use a PoE injector or a PoE hub.

**Do not supply power before the whole system is set up and connected properly.**  
**Always disconnect from electric mains power supply before cleaning or servicing.**  
**Damages caused by non-observance are not subject to warranty.**

## Setup and Operation

Follow the directions below, as they pertain to your preferred operation mode. Before plugging the unit in, always make sure that the power supply matches the product specification voltage.

### Setup

#### Setup Net-2 Install with Laptop/PC

- 01) Connect the Net-2 Install to the DMX inputs on the fixtures, using an XLR cable.
- 02) Connect the Net-2 Install to a network switch using a CAT5/CAT6 cable.
- 03) Connect the network switch to a laptop/PC using a CAT5/CAT6 cable. If no network is required, you can connect the Net-2 Install directly to the laptop/PC, using a CAT5/CAT6 cable.
- 04) Supply electric power.  
The Net-2 Install can be powered via the 2-pin Phoenix terminal or via the Ethernet connection using PoE. Do not supply power before the whole system is set up and connected properly.
- 05) Set the IP address of the lighting controller. The default IP address of the Net-2 Install is 2.0.0.1. To change the IP address of the Net-2 Install, see **2. IP Mode** on page 13. Refer to **Connecting to a Network** on page 9 for the correct network settings.

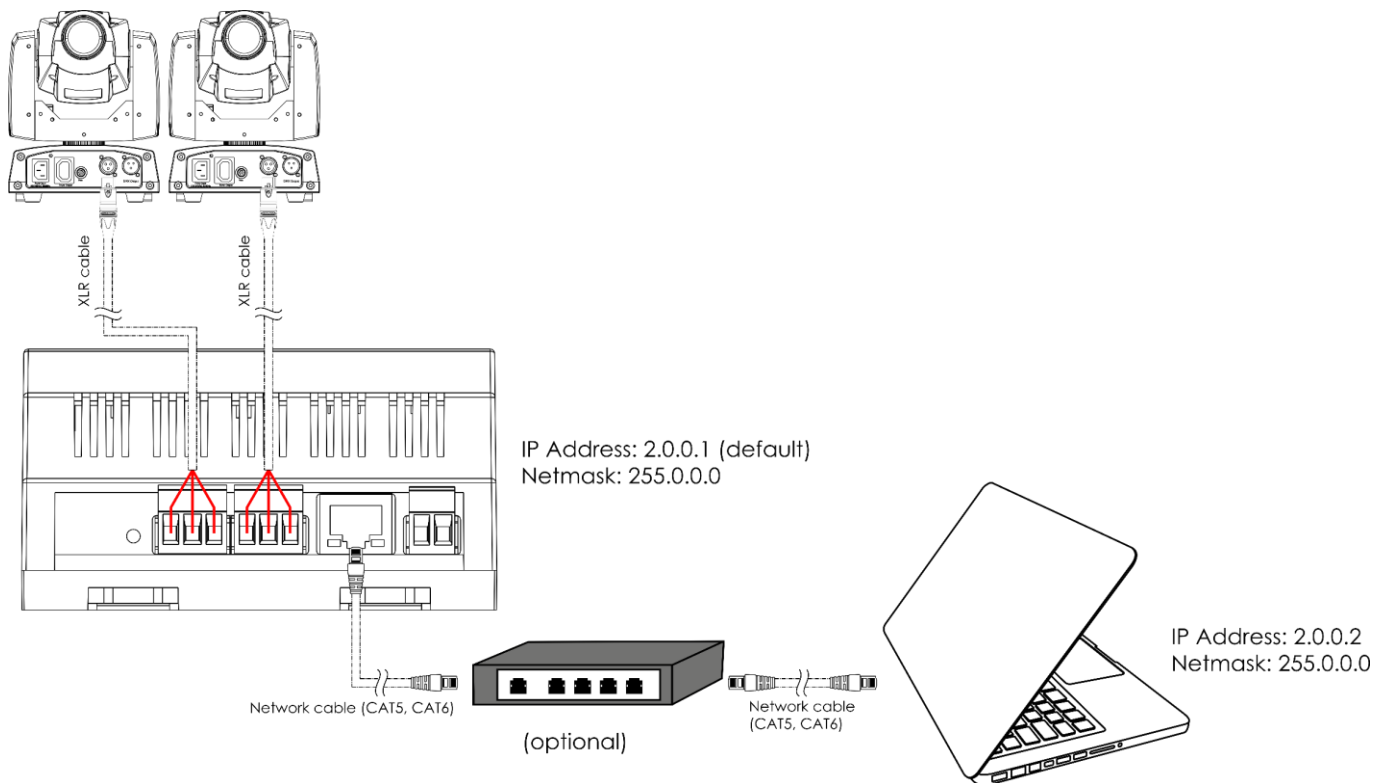

Fig. 03

**Note: Link all cables before connecting electric power**



### Setup Net-2 Install with Lighting Controller

- 01) Connect the Net-2 Install to the DMX inputs on the fixtures, using an XLR cable.
- 02) Connect the Net-2 Install to a network switch using a CAT5/CAT6 cable.
- 03) Connect the network switch to the lighting controller using a CAT5/CAT6 cable. If no network is required, you can connect the Net-2 Install directly to the lighting controller, using a CAT5/CAT6 cable.
- 04) Supply electric power.  
The Net-2 Install can be powered via the 2-pin Phoenix terminal or via the Ethernet connection using PoE. Do not supply power before the whole system is set up and connected properly.
- 05) Set the IP address of the lighting controller. The default IP address of the Net-2 Install is 2.0.0.1. To change the IP address of the Net-2 Install, see **2. IP Mode** on page 13. Refer to **Connecting to a Network** on page 9 for the correct network settings.

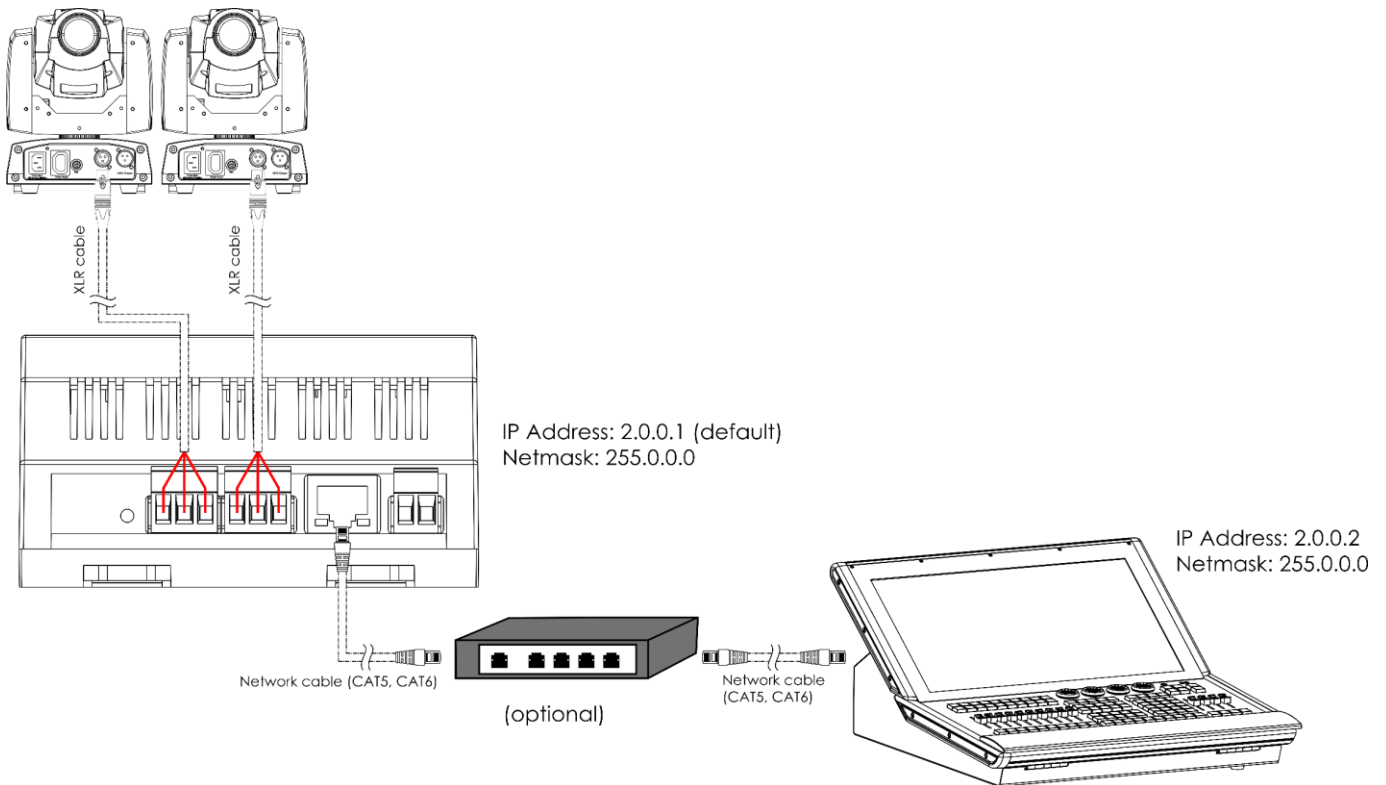

Fig. 04

**Note: Link all cables before connecting electric power**

## Connecting to a Network

### Art-Net Settings

- 01) Connect the device's Ethernet connector to a network switch, using a CAT5/CAT6 cable.
- 02) Set the IP address of your computer/lighting controller to **2.x.x.x** or **10.x.x.x**, depending on the Art-Net settings.
- 03) Set the Subnet mask to **255.0.0.0** on all devices.
- 04) Make sure that all fixtures in the network have a **unique IP address**.

Art-Net is a protocol that uses TCP/IP to transfer large amount of DMX-512 data over an Ethernet network. Art-Net 4 can support up to 32768 universes. Art-Net™ Designed by and Copyright Artistic Licence Holdings Ltd.

### sACN Settings

- 01) Connect the device's Ethernet connector to a network switch, using a CAT5/CAT6 cable.
- 02) Set the IP address of your computer/lighting controller. sACN networks have no restrictions on the IP address.
- 03) Set the Subnet mask on all devices.
- 04) Make sure that all fixtures in the network have a **unique IP address**.

sACN (streaming Architecture for Control Networks), also known as ANSI E1.31, is a protocol for sending DMX-512 data over IP networks developed by ESTA (Entertainment Services and Technology Association). It supports up to 63999 universes and uses multicasting.

## How to Make a Data Cable

A standard Ethernet cable can be used to replace the data cable required to transmit the data.

**Please follow the instructions below in order to create an extra network cable.**

Take a standard network cable (CAT-5/CAT-E/CAT-6) and connect it to an RJ45 connector, as shown on Fig. 05. The wires should now be colored as follows:

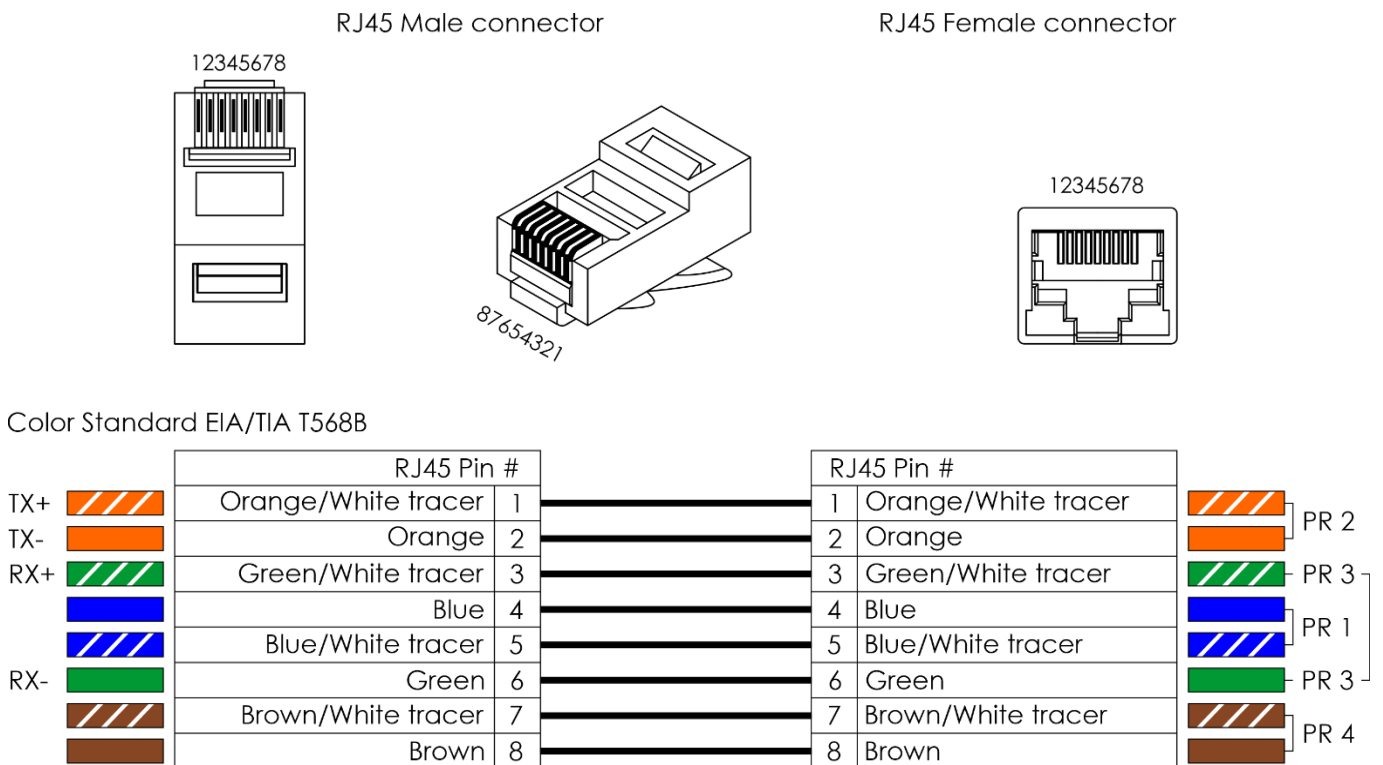

**Fig. 05**

### Fixture Linking

You will need a serial data link to run light shows of one or more fixtures using a DMX-512 controller or to run synchronized shows of two or more fixtures set to a master/slave operating mode. The combined number of channels required by all fixtures on a serial data link determines the number of fixtures the data link can support.

**Important:** Fixtures on a serial data link must be daisy-chained in a single line. To comply with the EIA-485 standard, no more than 30 devices should be connected on one data link. Connecting more than 30 fixtures on one serial data link without the use of a DMX optically isolated splitter may result in deterioration of the digital DMX signal.



Maximum recommended DMX data link distance: 100 meters

Maximum recommended number of fixtures on a DMX data link: 30 fixtures

### Data Cabling

To link fixtures together you must obtain data cables. You can purchase DAP Audio certified DMX cables directly from a dealer/distributor or construct your own cable. If you choose to create your own cable please use data-grade cables that can carry a high quality signal and are less prone to electromagnetic interference.

**Note:** Use of 3-pin XLR audio cables for DMX data transmission might lead to signal degradation and unreliable operation of the DMX network.

### Operation

The Net-2 Install can be configured to convert DMX signals into Art-Net or sACN and vice versa. The following configuration options are possible:

- Convert Art-Net/sACN to 2 x DMX outputs
- Convert 2 x DMX inputs to Art-Net/sACN
- Clone 1 x DMX input to 1 x DMX output and 1 x Art-Net/sACN
- HTP/LTP Merge 2 x Art-Net/sACN universes into 1 x DMX output
- HTP/LTP Merge 1 x DMX input and 1 x Art-Net/sACN into 1 x DMX output

When configured as output, each DMX port can merge up to 2 network sources. Merged data is sent to the DMX ports or looped back to Ethernet as a new universe. On each DMX port there can be enabled 2 different network universes: primary universe (main), and secondary universe (additional). Primary and secondary universes may have different protocols (Art-Net or sACN). Refer to **4. Set DMX Port** on page 15 for the configuration settings of the ports.

The device supports the following merging modes:

- SINGLE: Merging is disabled. The DMX signal is sent to the DMX port from the primary Art-Net or sACN universe.
- HTP (Highest Takes Precedence): the device will compare the values of the primary and secondary universes on the inputs and will send the **highest** value to the DMX port for each DMX channel in both universes.
- LTP (Latest Takes Precedence): the device will compare the values of the primary and secondary universes on the inputs and will send the **last changed** value to the DMX port for each DMX channel in both universes.

When configured as input, the DMX port can convert DMX-512 signal to Art-Net or sACN. The universe type and protocol for the input port is always taken from the primary universe. The Net-2 Install supports also BACKUP function. In case of a failure, or when there are no DMX values on the primary Art-Net/sACN universe for more than 3 seconds, the Net-2 Install starts sending the DMX values from the backup port.

## Control Panel

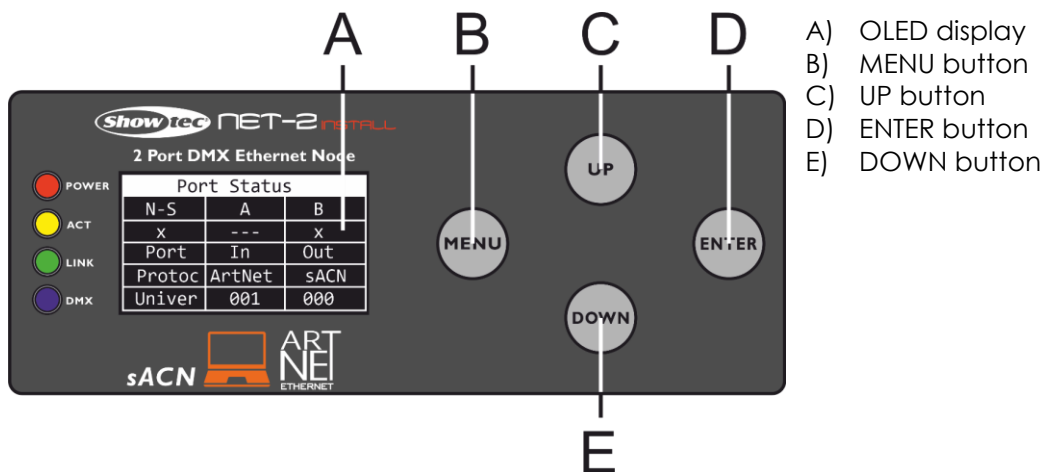

Fig. 06

- Use the **UP/DOWN** buttons to navigate through the menus, to increase/decrease numeric values or to scroll through a set of characters.
- Use the **ENTER** button to open the desired menu or to set the currently selected value.
- Use the **MENU** button to exit the current menu and/or to return to the Main Menu.

**If the display is rotated at 180°, the function of the buttons on the control panel will be reversed.**

To change the orientation of the display, see **5. Set Display** on page 16.

- The **MENU** button will function as **ENTER** button and vice versa.
- The **UP** button will function as **DOWN** button and vice versa.

## Status Menu

At start-up, the OLED display shows the status menu. The status menu provides information about the device and the settings of the 2 ports.

01) Press the **UP/DOWN** buttons to navigate between the 2 start screens:

Device Info	
NET-2	
IP:2:0:0:1	
Mask:255.0.0.0	

### DEVICE INFO

- Name of the device. To change the name, see **1. Rename** on page 13.
- IP address of the device. To set the IP address, see **2. IP Mode** on page 13.
- Netmask of the device. To set the Netmask, see **3. Netmask** on page 14.

Port Status		
N-S	A	B
x	---	x
Port	In	Out
Protoc	ArtNet	sACN
Univer	001	000

### PORT STATUS

- N-S: Network Status of Port A and Port B
- x: (✓) the port is connected; (x) the port is not connected; (---) the port is disabled
- Port: In – the port is input; Out – the port is output
- Protoc: ArtNet or sACN protocol
- Univer: Art-Net/sACN universe

- 02) Press the **MENU** button to enter the Main Menu.
- 03) If no button is pressed, after 45 seconds the display returns to one of the 2 start screens. Press the **UP**, **DOWN**, **MENU** or **ENTER** button to return to the Main Menu.

## Menu Overview

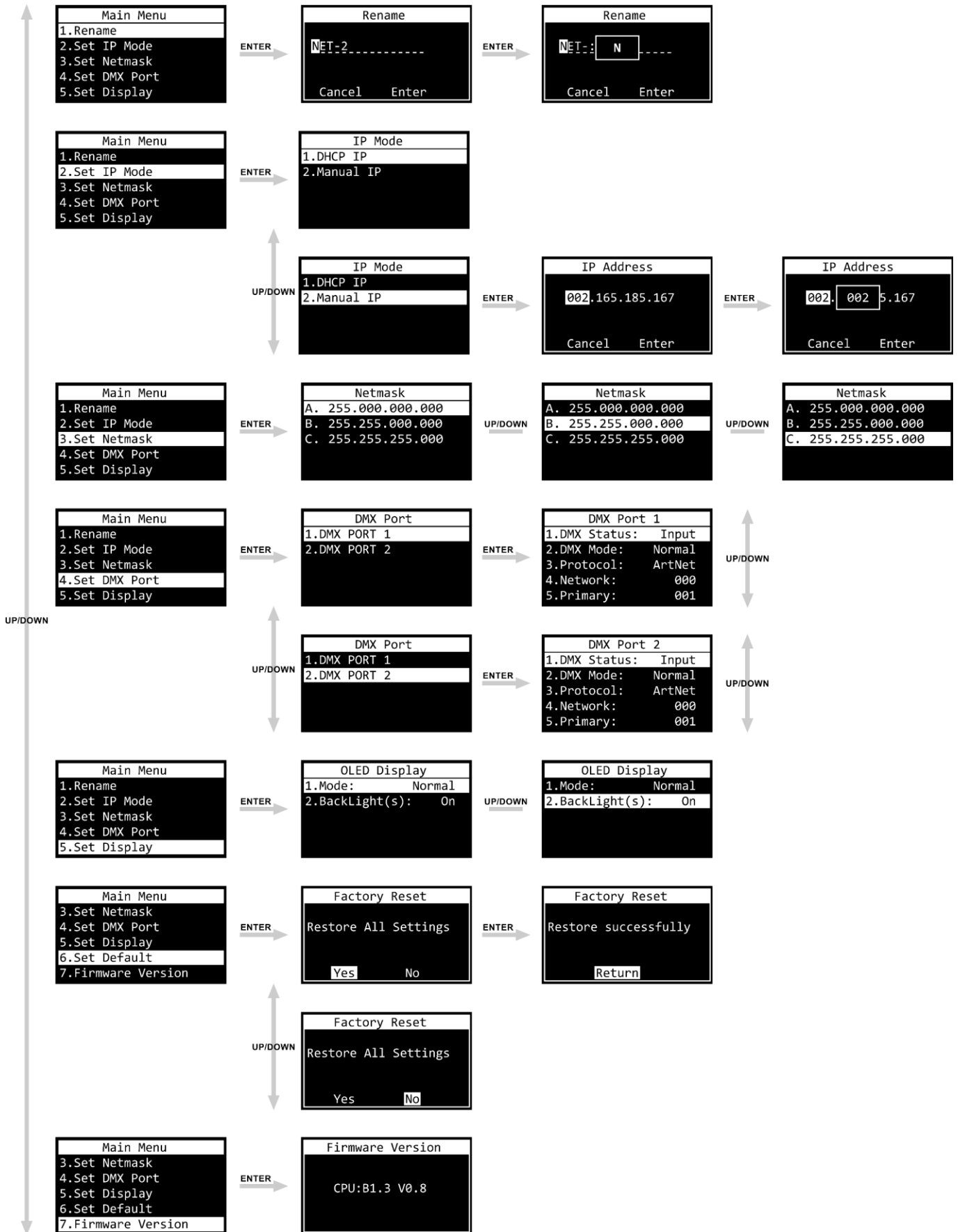

## Main Menu Options

The Main Menu has the following options:

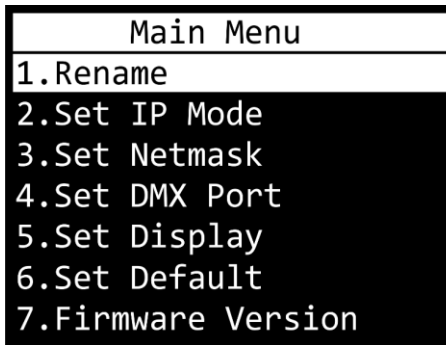

Press the **UP/DOWN** buttons to navigate through the Main Menu. Press the **ENTER** button to open the submenu. Press the **MENU** button to return to the Main Menu.

### 1. Rename

In this menu you can change the name of the device.

- 01) Press the **UP/DOWN** buttons to move the cursor respectively to the left or to the right on the display. When the cursor reaches the last available position on the line, it will move to the second line.
- 02) Press the **ENTER** button to confirm the selection. The selected character will be highlighted.

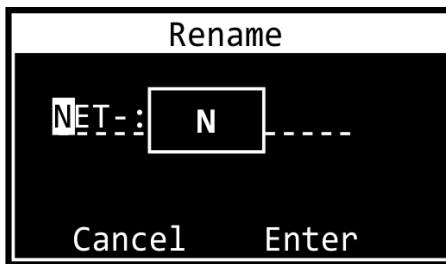

- 03) Press the **UP/DOWN** buttons to change the character. The available characters are lowercase and uppercase letters, digits, punctuation marks, and some symbols.
- 04) Press the **ENTER** button to confirm.
- 05) Press the **MENU** button if you want to cancel and return to step 1.
- 06) Repeat steps 1–4 for each character of the name. The maximum length of the name is 16 characters.
- 07) Press the **UP/DOWN** buttons to select CANCEL (to discard changes) or ENTER (to confirm the new name).
- 08) Press the **ENTER** button to confirm.

### 2. IP Mode

In this menu you can configure the IP address of the device.

- 01) Press the **UP/DOWN** buttons to toggle between the 2 options:

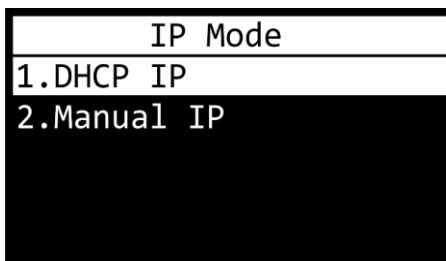

- 02) Press the **ENTER** button to confirm your choice.

### 2.1. DHCP IP

If you choose DHCP IP, the IP address of the device will be generated automatically by the network server.

### 2.2. Manual IP

To configure the IP address of the device manually:

- 01) Press the **UP/DOWN** buttons to move the cursor respectively to the left or to the right on the display. When the cursor reaches the last available position on the line, it will move to the second line.
- 02) Press the **ENTER** button to confirm the selection. The selected number will be highlighted.

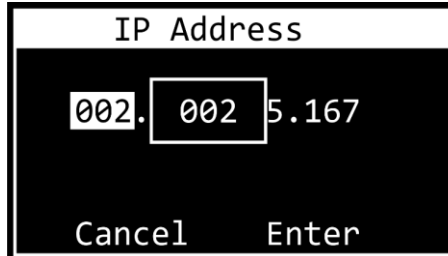

- 03) Press the **UP/DOWN** buttons to change the number. The selection range is between 0 and 255. Alternatively, press and hold down the **UP/DOWN** buttons for quick search.
- 04) Press the **ENTER** button to confirm.
- 05) Press the **MENU** button if you want to cancel and return to step 1.
- 06) Repeat steps 1 – 4 for each of the 4 sections.
- 07) Press the **UP/DOWN** buttons to select CANCEL (to discard changes) or ENTER (to confirm the IP address).
- 08) Press the **ENTER** button to save the IP address.

### 3. Set Netmask

In this menu you can set the Netmask of the IP address.

- 01) Press the **UP/DOWN** buttons to scroll through the 3 options:

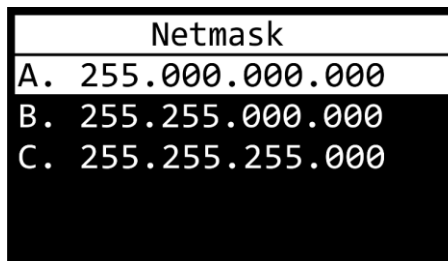

- 02) Press the **ENTER** button to confirm the selection.

## 4. Set DMX Port

In this menu you can configure the 2 DMX ports.

- 01) Press the **UP/DOWN** buttons to choose between Port 1 and Port 2.
- 02) Press the **ENTER** button to confirm your choice. The display shows:

DMX Port 1	
1.DMX Status:	Output
2.DMX Mode:	LTP
3.Protocol:	ArtNet
4.Frame Rate:	40Hz
5.Network:	000
6.Primary:	000
7.Secondary:	002
8.Resend:	004

- 03) Press the **UP/DOWN** buttons to scroll between the following settings:
  1. DMX STATUS: Define the port direction.
    - INPUT: The port will be used as an input.
    - OUTPUT: The port will be used as an output.
    - DISABLE: The port will be disabled.
  2. DMX MODE (Depends on whether the port is set as an input or output.)
    - If the port is set as **input**:
      - NORMAL: Input port acts as a primary controller. The DMX port receives the DMX signal and sends it to the primary Art-Net/sACN universe.
      - BACKUP: Input port acts as a backup controller.
    - If the port is set as **output**:
      - SINGLE: Merging is disabled.
      - HTP: Highest Takes Precedence function is enabled.
      - LTP: Latest Takes Precedence function is enabled.
  3. PROTOCOL: Choose between Art-Net and sACN.
  4. FRAME RATE: Set the DMX data refresh rate. The frame rate can be set within the range 10–40 Hz, in increments of 5 Hz. **This setting is available only when the port is set as output.**
  5. NETWORK: Set the Art-Net/sACN network of the Net-2 Install (0–255).
  6. PRIMARY: Set the primary Art-Net/sACN universe dedicated to this port (0–255).
  7. SECONDARY: Set the secondary Art-Net/sACN universe dedicated to this port (0–255). **This option is available only when the port is set as output and the DMX mode is set to HTP or LTP.**
  8. RESEND: The Net-2 Install can send the merged signal back onto the network as a new universe. This setting determines which universe to rebroadcast onto the network. This function is available when the network of the port is set between 0–127. For the 128–255 network range this function is disabled. **This option is available only when the port is set as output and the DMX mode is set to HTP or LTP.**
- 04) Press the **ENTER** button to select the desired setting. The selection will be highlighted.
- 05) Press the **UP/DOWN** buttons to change the values.
- 06) Press the **ENTER** button to set the value.



### 5. Set Display

In this menu you can set the orientation of the OLED display and the amount of time the backlight stays on after the last button is pressed on the control panel.

01) Press the **UP/DOWN** buttons to toggle between the 2 options:



#### 1. MODE

- NORMAL: normal orientation of the OLED display
- INVERSE: the OLED display is rotated at 180°.

**Note: If the display is rotated at 180°, the function of the buttons on the control panel will be reversed as well.**

- The **MENU** button will function as **ENTER** button and vice versa.
- The **UP** button will function as **DOWN** button and vice versa.

#### 2. BACKLIGHT(S)

- ON: the backlight of the OLED display does not turn off
- 10: the backlight turns off automatically after 10 seconds of inactivity
- 30: the backlight turns off automatically after 30 seconds of inactivity

02) Press the **ENTER** button to confirm your choice.

03) Press the **UP/DOWN** buttons to change the values.

04) Press the **ENTER** button to set the value.

### 6. Set Default

In this menu you can restore the default factory settings.

01) Press the **UP/DOWN** buttons to toggle between Yes and No.

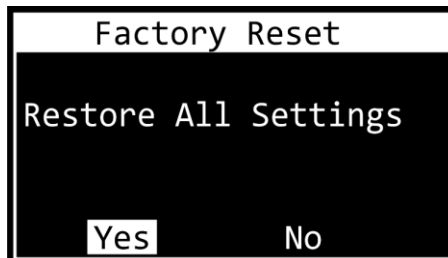

02) Select Yes (to reset all settings to factory defaults) or No (to cancel the reset and exit) and press the **ENTER** button to confirm your choice.

03) If you have selected Yes, press the **ENTER** button to return to the Main Menu.

### 7. Firmware Version

This menu shows the firmware version:



## Settings Configuration via Web Browser

The Net-2 Install can be configured remotely via web interface.

- 01) Connect the Net-2 Install to a laptop/computer.
- 02) Configure the network address of the laptop /computer in the correct range (IP 2.x.x.x or 10.x.x.x and Subnet 255.0.0.0).
- 03) Open your web browser and enter the IP address of the Net-2 Install in the address bar. For the current IP address of the device, check the Status Menu on the display of the device (see **Status Menu** on page 11).
- 04) Press Enter on the laptop/computer keyboard.
- 05) Enter the log-in details when prompted:
  - Log-in account: Admin
  - Password: Admin (You can change the password after you log in.)

The web interface offers the same configuration settings as the control panel. For the available configuration options, refer to the respective sections in **Main Menu Options** on pages 13–16.

**Note:** If you change a setting via the control panel, you need to refresh the web browser to see the new setting in the browser window.



# NET-2

## 2 Port DMX Ethernet Node

Device Settings

Device Name	NET-2	New Password	
DHCP Mode	Manual IP	LCD Backlight	On
IP Address	2.255.31.196	Display Direction	Normal
Net Mask	255.0.0.0	Factory Reset	No
Firmware Version	B1.3 V0.8		

Port Settings

DMX Port 01		DMX Port 02	
DMX Status	Output	DMX Status	Output
DMX Mode	Single	DMX Mode	Single
Protocol	ArtNet	Protocol	ArtNet
Frame Rate	40Hz	Frame Rate	40Hz
Network	0	Network	0
Primary	0	Primary	1

Firmware Upgrade

Please select a firmware file.

**File Path:** Bestand kiezen   Geen bestand gekozen   Upload File

Tips: If no activity after 20 seconds, please re-upload. Do not attempt to re-upload prior to the 20 seconds.

- Use the drop-down menus or enter the respective values to configure the settings of the device and the 2 DMX ports.
- Click on **Apply** to save the changes.
- Click on **Cancel** to discard the changes.

### Changing the Password

To change the password, proceed as follows:

- 01) Log in with your current password.
- 02) Enter the new password in the New Password field.
- 03) Click **Apply** to save the changes.



**Do not lose your password. Once it is lost, it cannot be retrieved.**



### Updating the Firmware

The firmware of the Net-2 Install can be updated via the web interface. You can download the update from the product's page on [www.Showtec.info](http://www.Showtec.info).

- 01) Click **Choose File** and browse to the location where the firmware update file is saved.
- 02) Select the file.
- 03) Click Open on the dialog box to confirm the selection.
- 04) Click **Upload File** to start the firmware update process.
- 05) Follow the instructions on the browser to complete the update.

**Note:** It can take up to 20 seconds to update the firmware. Do not click any buttons before the update is complete.

After completion of the firmware update, reset the Net-2 Install to factory defaults. When you update the firmware, all previously configured settings will be lost.

## Maintenance

---

The operator has to make sure that safety-related and machine-technical installations are to be inspected by an expert after every year in the course of an acceptance test.

The operator has to make sure that safety-related and machine-technical installations are to be inspected by a skilled person once a year.

The following points have to be considered during the inspection:

- 01) All screws used for installing the device or parts of the device have to be tightly connected and must not be corroded.
- 02) There may not be any deformations on housings, fixations and installation spots.
- 03) The electric power supply cables must not show any damages or material fatigue.

The Showtec Net-2 Install requires almost no maintenance. However, you should keep the unit clean. Disconnect the mains power supply and then wipe the cover with a damp cloth. Wipe the front glass panel clean with glass cleaner and a soft cloth. Do not use alcohol or solvents. Do not immerse in liquid. Keep connections clean. Disconnect electric power, and then wipe the DMX connections with a damp cloth. Make sure connections are thoroughly dry before linking equipment or supplying electric power.

## Troubleshooting

This troubleshooting guide is meant to help solve simple problems. If you are unable to determine the cause of the problem, do not open the unit, as this may damage the device and the warranty will be deemed void. Return the device to your Showtec dealer.

Problem	Probable cause(s)	Solution
One or more fixtures do not function at all	No power to the fixture (Power LED indicators are off)	<ul style="list-style-type: none"> <li>• Make sure the Net-2 Install is properly connected to the power supply. Make sure the power output works and supplies proper voltage</li> <li>• If using PoE, make sure the Ethernet cable is properly connected to a network switch. Make sure the network switch is PoE compatible</li> </ul>
	Art-Net or sACN protocol is not active (Link LED indicators are off)	<ul style="list-style-type: none"> <li>• Configure and activate Art-Net/sACN</li> </ul>
The device responds erratically	The factory settings of the device are changed	<ul style="list-style-type: none"> <li>• Reset the device's parameters to the default factory settings. See <b>6. Set Default</b> on page 16</li> </ul>
Fixtures reset correctly, but all respond erratically or not at all to the controller	The DMX output of the node does not match XLR IN of the first fixture on the link (i.e. signal is reversed) (DMX LED indicators are off)	<ul style="list-style-type: none"> <li>• Install a phase reversing cable between the node and the first fixture on the link</li> </ul>
Fixtures reset correctly, but some respond erratically or not at all to the controller	Poor data quality	<ul style="list-style-type: none"> <li>• Check data quality. If much lower than 100 %, the problem may be a bad data link connection, poor quality or broken cables, missing termination plug, or a defective fixture disturbing the link</li> </ul>
	Bad data link connection	<ul style="list-style-type: none"> <li>• Inspect connections and cables. Correct poor connections. Repair or replace damaged cables</li> </ul>
	Data link not terminated with 120 Ohm termination plug	<ul style="list-style-type: none"> <li>• Insert termination plug in output jack of the last fixture on the link</li> </ul>
	Incorrect addressing of the fixtures	<ul style="list-style-type: none"> <li>• Check address settings</li> </ul>
	Frame rate is too low or too high	<ul style="list-style-type: none"> <li>• Adjust the DMX data refresh rate</li> </ul>
	One of the fixtures is defective and disturbs data transmission on the link	<ul style="list-style-type: none"> <li>• Bypass one fixture at a time until normal operation is restored: unplug both connectors and connect them directly together</li> <li>• Have the defective fixture serviced by a qualified technician</li> </ul>

## Product Specifications

Model:	Showtec Net-2 Install
Power supply:	12–36 V DC, 500 mA or PoE (802.3af)
Power consumption:	6 W
Dimensions:	105 x 98 x 58 mm (LxWxH)
Weight:	0,18 kg
<b>Operation and programming</b>	
DMX:	2 universes (IN and/or OUT)
Control modes:	Art-Net, sACN, TCP/IPv4, DMX-512-A
Ethernet speed:	10/100Base-T
Setup:	Control panel, web interface
Merging options:	HTP, LTP, Normal, Backup
DMX data refresh rate:	40 Hz default (adjustable 10–40 Hz)
<b>Electro-mechanical properties</b>	
IP rating:	IP20
Display:	OLED
Data connection:	3-pin Phoenix terminal (maximum cable gauge: 1,5 mm <sup>2</sup> / AWG: 12), RJ45
Power connection:	2-pin Phoenix terminal (maximum cable gauge: 1,5 mm <sup>2</sup> / AWG: 12)
Housing:	UL94-V0 flame-retardant polycarbonate
Color:	Gray
Mounting:	35-mm DIN rail system (DIN EN43880 form factor; DIN EN60715 rail system)
Mounting size:	6 TE
Operating temperature:	0–40 °C
Max. ambient temperature $t_a$ :	40 °C
Max. housing temperature $t_B$ :	70 °C
<b>Minimum distance:</b>	
Min. distance from flammable surfaces:	0,5 m

Design and product specifications are subject to change without prior notice.



Website: [www.Showtec.info](http://www.Showtec.info)  
 Email: [service@highlite.com](mailto:service@highlite.com)

## Dimensions

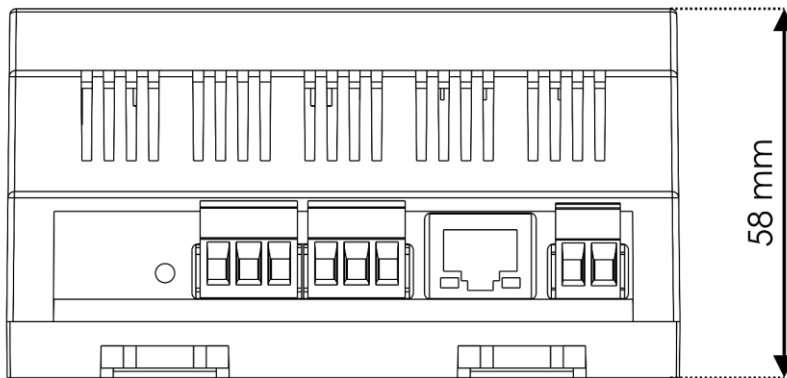
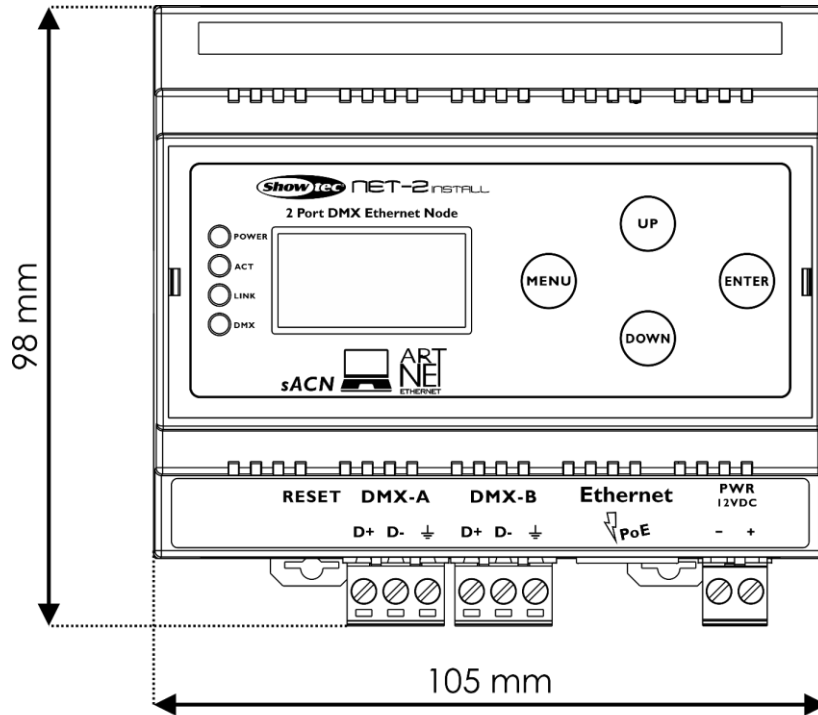





©2020 Showtec