



M-7X

Stage Fog Machine

User Manual



English · 中文

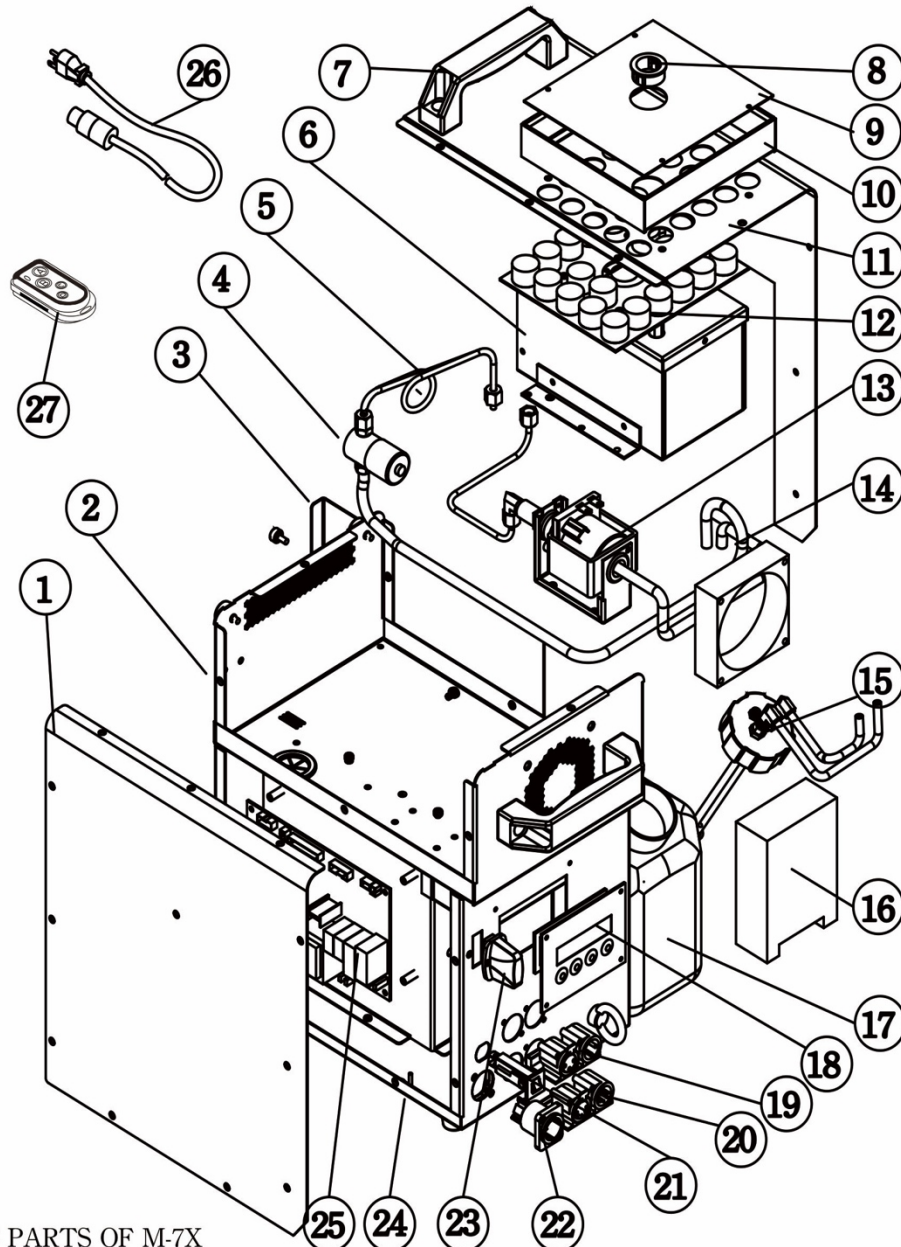

SPARE PARTS OF M-7X

① M007XLH10	Steel Case/Left Cover	⑮ M-7X-TKC(TKC5A00BA)	Tank Cover
② M007X0110	Steel Case/UP Base	⑯ M-7X-POW	LED Power Supply
③ M007A0301-M7X	Steel Case/Tank Cover	⑰ M-7X-TK(TK1024000)	Tank Cover
④ M-7X-LUS(LUS1A047A)	Solenoid Valve (Group)	⑱ M-7X-PCBC	Control P.C Board
⑤ M-7X-CP	Brass Tube	⑲ M-7X-PCBD3(DMX3P00AB)	P.C Board DMX 3Pin
⑥ M-7X-H	Heater	⑳ M-7X-PCBD5(DMX5P00A5)	P.C Board DMX 5Pin
⑦ C02013500	Handle	㉑ C04101400	Breaker
⑧ D04012000	Snap Bushing	㉒ C04312620	Power Inlet
⑨ C02012100	LED Protect	㉓ W-2RA	W-2 Receiver
⑩ Z15200800-ATR	LED Cover	㉔ M0070001-M7X	Steel Case/Down Base
⑪ M007XRH10	Steel Case/Right Cover	㉕ M-7X-PCB	Main P.C Board
⑫ M-7X-LED	LED (Group)	㉖ M-7X-PC(PCA014201)	Power Cord & Plug
⑬ M-7X-P(PA0EX5A20)	Pump (Group)	㉗ W-2A	Wireless transmitter
⑭ M-7X-FAN	Fan		

Note: This is an exploded diagram of 120V machine, For 220-240V, please contact your local Antari dealer or us.



User Manual

Safety Information



Please read the following safety information carefully before operating the machine. Information includes important safety information about installation, usage, and maintenance. Pay attention to all warning labels and instructions in this manual and printed on the machine.

If you have questions about how to operate the machine safely, please contact your local Antari dealer for help.

- Keep this device dry.
- Always connect to a grounded circuit to avoid risk of electrocution.
- Before connecting the machine to power, always check the voltage indicated on the machine matches to your local AC voltage. Do not use the machine if AC power voltage does not match.
- Disconnect the machine from AC power before servicing and when not in use.
- If the supply cord is damaged, contact your local Antari dealer for replacement.
- This product is for indoor use only! Do not expose to rain or moisture. If fluid is spilled, disconnect AC power and clean with a damp cloth. If fluid is spilled onto electronic parts, immediately unplug the machine and contact your local Antari dealer for advice.
- No user serviceable and modifiable parts inside. Never try to repair this product, an unauthorized technician may lead the machine to damage or malfunction.
- For adult use only. Children being supervised not to play with the machine. Never leave the machine running unattended.
- The machine is not to be used by persons (including children) with reduced physical, sensory or mental capabilities, or lack of experience and knowledge.
- Installed in a well ventilated area. Provide at least 50 cm space around the machine.
- Never add flammable liquid of any kind to the machine.

- Make sure there are no flammable materials close to the machine while operating.
- Only use Antari fluid. Other fluid may lead to heater clog and malfunction.
- If the machine fails to work, unplug the machine and stop operation immediately. Contact your local Antari dealer for .
- Before transporting the machine, make sure the fluid tank is completely drained.
- Smoke fluid may present health risks if swallowed. Do not drink smoke fluid. Store it securely. In case of eye contact or if fluid is swallowed immediately look for medical advice.

Unpacking and Inspection

Immediately upon receiving the machine, carefully unpack the carton, check all content to ensure that all parts are present and have been received in good condition. If any parts appear damaged or mishandled from shipping, notify the shipper immediately and retain the packing material for inspection.

What is included:

- 1 x M-7X Fogger
- 1 x W-2 Wireless Remote
- 1 x Power Cord
- 1 x User Manual

Product Dimension



Product Overview

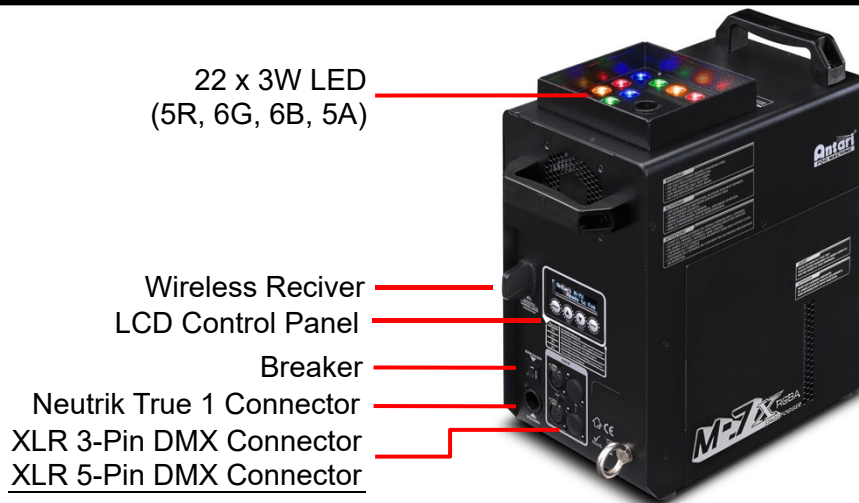

Setting Up

Step 1: Place the machine on a flat surface and in a suitably large area with at least 50 cm open space around the machine.

Step 2: Fill the fluid tank with Antari approved fluid.

Step 3: Connect the machine to suitably rated power supply. To determine the power requirement for the machine refer to the label on the back of the machine.



Always connect the machine to a protected circuit and ensure it is properly grounded to avoid risk of electrocution.

Step 4: Turn on the machine and allow it to heat up. Heat up takes approximately 5 minutes. Once the machine has reached operating temperature, the LCD display will show "Ready To Fog". Now the machine is ready for operation.

Step 5: To start making fog, locate the **Volume** button on the control panel, and press the button to start making fog.

Step 6: To turn off the machine, press **STOP** button and turn Powercon to the **OFF** position.

Operation

Control Panel Operation

The machine can be operated with an onboard digital control interface



Button	Function
[MENU]	Scroll through setting menu
▲ [UP]/[TIMER]	Up/Activate Timer function
▼ [DOWN]/[VOLUME]	Down/Activate Volume function
[STOP]	Deactivate Timer/Volume function/Return to Standby

Control Menu

DMX512 Address: 1	Set DMX address from 1 to 504
Stand Alone Set Master/Slave	Set machine as Master of Slave unit
Color Mode On/Off	Turn built-in LED color mode On or Off
Color Mode Marco:01-10	Set LED output color from macro 1 to 10

<p>Color Mode Chase:01-15</p>	<p>Set LED chase from 1 to 15</p>
<p>Timer Interval 15 Sec</p>	<p>Set interval from 15 to 360 seconds</p>
<p>Timer Duration 01-05 Sec</p>	<p>Set duration from 1 to 5 seconds</p>
<p>Wireless Setting On</p>	<p>Turn On or Off W-2 wireless control function</p>
<p>Wireless Setting Button A:M01/Off</p>	<p>Set wireless remote button function macro color 1 to 10 or chase 1 to 15 and off.</p>
<p>Wireless Setting Button B:M01/Off</p>	<p>Set wireless remote button function macro color 1 to 10 or chase 1 to 15 and off.</p>
<p>Wireless Setting Button C:M01/Off</p>	<p>Set wireless remote button function macro color 1 to 10 or chase 1 to 15 and off.</p>
<p>Wireless Setting Button D:M01/Off</p>	<p>Set wireless remote button function macro color 1 to 10 or chase 1 to 15 and off.</p>
<p>LED Setting Fog Only/Always On</p>	<p>Setting for LED to turn on with fog only or always on.</p>
<p>LED Fade Out Delay: 0 Sec</p>	<p>Set LED delay time before off from 0.3-0.5 or 0-5 seconds.</p>

Run Last Setting
On/Off

Turn On/Off run last setting function

2-7 Sec Jet Mode
Off/2-7s

Turn On/Off 2-7 Sec Jet Mode; Jet output can be set between 2-7 seconds

W-DMX512
On/Off

Turn On/Off W-DMX

W-DMX Reset
Yes

Rest W-DMX connection

Wireless Operation

Wireless remote control system W-2 consist of a transmitter equipped with four buttons to activate four user configurable LED setting and fog; with an onboard receiver attach to the rear panel of M-7X.



W-2 Wireless Transmitter



Wireless Receiver

Wireless settings are configurable through onboard control panel, refer to control menu section to setup each buttons.

In an open unobstructed space the effective distance is 50 meters, the effective distance depending on obstacle level is 10-25 meters.

Registering transmitter

The transmitter can be paired or deleted from the receiver. Each receiver can pair up to 10 transmitters. Follow the steps below to pair or delete a transmitter from the receiver.

Step 1: Power off M-7X Fogger

Step 2: Press and hold [DOWN] button

Step 3: Turn power on and release [DOWN] button when LCD display blinks

Step 4: Follow the menu instruction to pair or delete transmitter

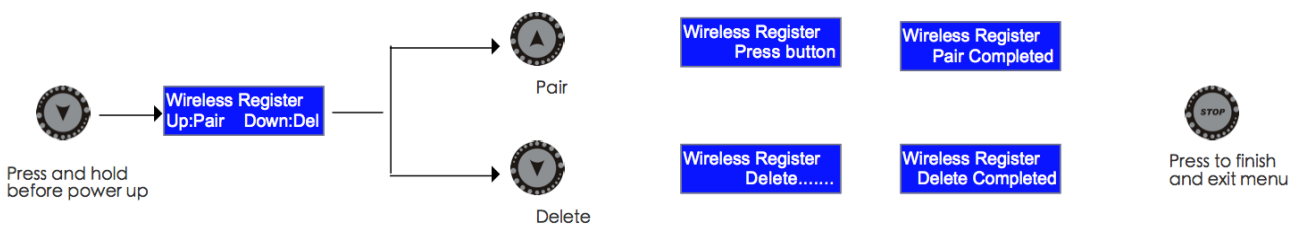

Transmitter battery replacement

If the effective distance appears to be decreased, it is possible the battery level is low and require replacement. In order to replace the battery, undo the three screws on the back of transmitter to release the cover. Replace with the same type and specification of battery which is 27A 12V

DMX Connector Pin Assignment

The machine provides 3 or 5 pin XLR connector for DMX connection. The diagram below indicates pin assignment information.

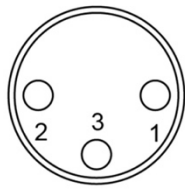

3 Pin XLR

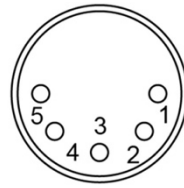
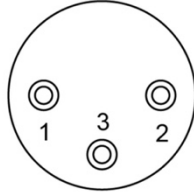

5 Pin XLR

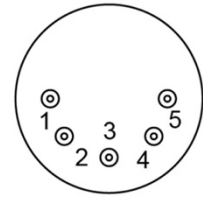

Pin	Function
1	Ground
2	Data-
3	Data+
4	N/A
5	N/A

DMX Channel Function

Channel 1	DMX Value Range	Function
Fog	0 – 4	Fog Off
	5 – 255	Fog On (lasts for 20s)
Channel 2	DMX Value Range	Function
Red LED	0-255	0-100%
Channel 3	DMX Value Range	Function
Green LED	0-255	0-100%
Channel 4	DMX Value Range	Function
Blue LED	0-255	0-100%
Channel 5	DMX Value Range	Function
Amber LED	0-255	0-100%
Channel 6	DMX Value Range	Function
Chase	1-15	Chase 1
	16-31	Chase 2
	32-47	Chase 3
	48-63	Chase 4
	64-79	Chase 5
	80-95	Chase 6
	96-111	Chase 7

	112-127	Chase 8
	128-143	Chase 9
	144-159	Chase 10
	160-175	Chase 11
	176-191	Chase 12
	192-207	Chase 13
	208-223	Chase 14
	224-255	Chase 15
Channel 7	DMX Value Range	Function
Chase Speed	0-255	0-255 step per min
Channel 8	DMX Value Range	Function
Master Dimmer	0-255	0-100%
Channel 9	DMX Value Range	Function
Strobe	0-255	1-20 Hz

Fluid

Use Antari FLC water-based Fluid for the best effect for the M-7X Fogger. The machine is tested and calibrated with this liquid to get the best output performance. Warranty will be voided if any other type of liquid is used, improper use of liquid may lead to machine failure and malfunction.

Service and Maintenance

- . Do not allow the machine to become contaminated.
- . Remove dust from air vents with air compressor, vacuum or a soft brush.
- . Only use a damp cloth to clean the casing.
- . Before storing run distilled water through the system to help avoid condensing the pump or heater.
- . It is recommended to run the machine on a monthly basis in order to achieve best performance and output condition.
- . Excessive dust, liquid and dirt built up will degrade performance and cause overheating.

Breaker Reset



Disconnect AC power before reset breaker. Only replace fuse with same type and rating.

Step 1: Disconnect AC power

Step 2: Flip breaker to ON position

Step 3: Turn on machine to test

Breaker

100V = 16A 250V

120V = 15A 250V

240V = 9A 250V



Technical Specifications

- Input voltage	US model : AC 100-120V, 50 / 60Hz 13A EU model : AC 220-240V, 50 / 60Hz 6.5A
- Rated power	1516W
- Light source	22 x 3W LED (5 Red, 6 Green, 6 Blue, 5 Amber)
- Warm-up time	7 minutes (approx.)
- Fluid consumption	200 ml/min
- Fluid tank capacity	2.4L (0.63gal)
- Compatible fluid	Antari FLC Super Light Fog Fluid
- Ambient temp. range	0°C - 40 °C (32 °F-104 °F)
- Output	10 meters height
- Control	DMX512, Timer, Manual, Wireless, Master/Slave Wireless DMX (Optional)
- DMX channels	9 channels
- Connection	Neutrik TRUE 1 Connector (Power) XLR 3-pin and 5-pin (DMX)
- Optional accessories	WTR-90 Wireless DMX
- Dimension	L344 W193 H381 mm (L13.54 W7.60 H15 inch)
- Weight	14 kg (30.8 lbs)