



# DNG-250 Low Fog Generator User Manual

- ENGLISH



## **DNG-250** **LOW FOG GENERATOR**

© 2019 Antari Lighting and Effects Ltd.

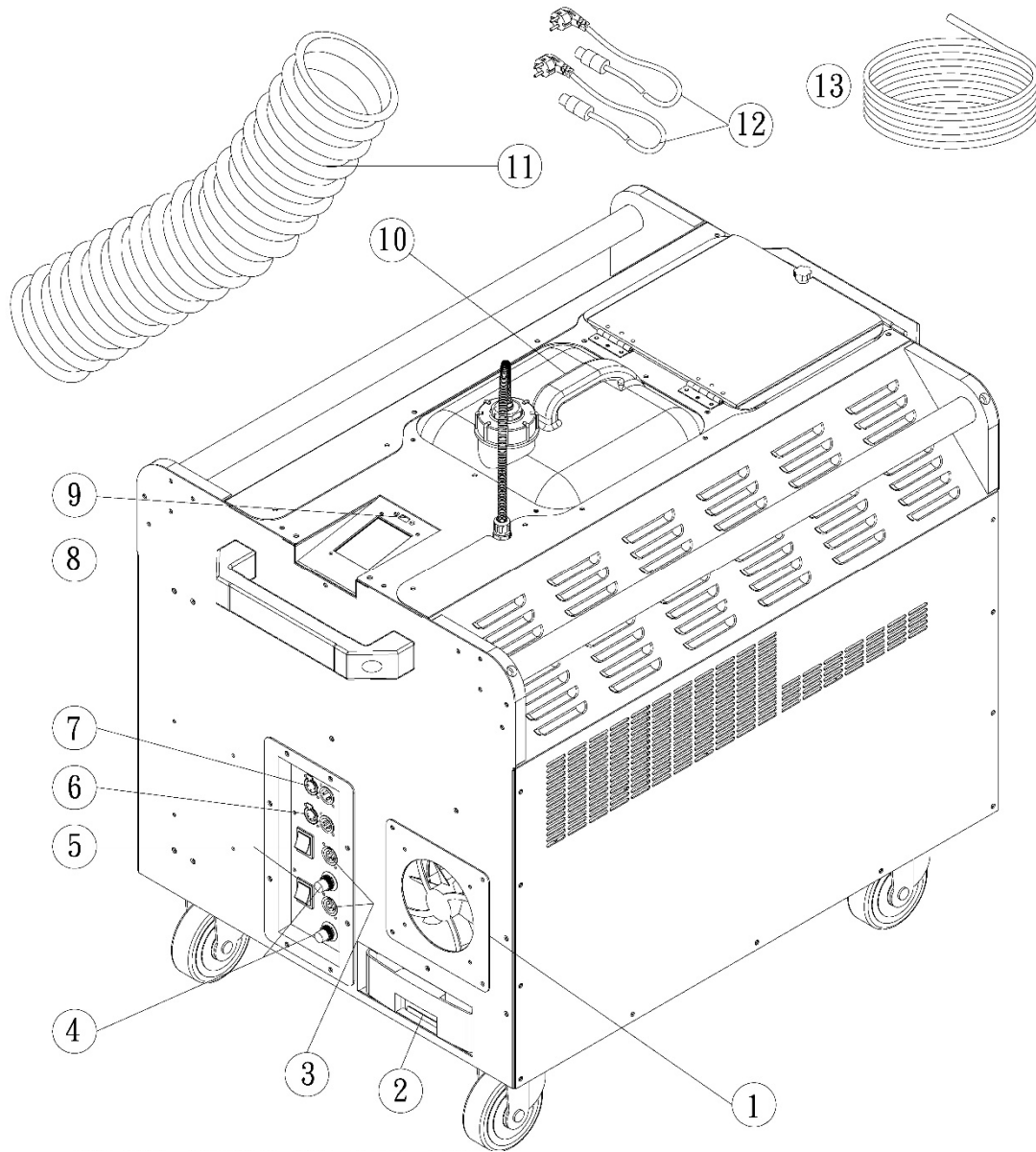

Spare Parts of **DNG-250**  
LOW FOG GENERATOR

- |                       |                         |
|-----------------------|-------------------------|
| 1. Fan                | 8. LCD-TFT              |
| 2. Catchment          | 9. USB                  |
| 3. Power Socket       | 10. Tank & tank cap     |
| 4. Resettable Fuse    | 11. Fog Conducting Hose |
| 5. Rocker Switch      | 12. Power Cord & Plug   |
| 6. P.C Board DMX 5Pin | 13. Pu Tube             |
| 7. P.C Board DMX 3Pin |                         |

# DNG-250 LOW FOG GENERATOR

---

Thank you for choosing Antari's DNG-250 Low Fog Generator. The machine has some terrific new features on top of the ones of its previous version DNG-200. With the 3.5 TFT color touch panel, users can operate more easily. The dimension is exactly the same as DNG-200, but the output volume and continuity are comprehensively increased, hence a total up-grade in performance. No CO<sub>2</sub> is needed for DNG-250 Low Fog Generator; therefore, there's no risk to human body nor environment. DNG-250 is a real green effect machine.

Please follow these operation, safety and maintenance instructions to ensure a longer and safe life of your DNG-250 Low Fog Generator.

Pay attention to all warning labels and instructions printed on the exterior of the machine.

## Safety Instructions

If you have questions about how to operate the machine safely, please contact your local Antari dealer for help.

- Keep this device dry.
- Always connect to a grounded circuit to avoid risk of electrocution.
- Before connecting the machine to power, always check the voltage indicated on the machine matches to your local AC voltage. Do not use the machine if AC power voltage does not match.
- Disconnect the machine from AC power before servicing and when not in use.
- If the supply cord is damaged, contact your local Antari dealer for replacement.
- This product is for indoor use only! Do not expose to rain or moisture. If fluid is spilled, disconnect AC power and clean with a damp cloth. If fluid is spilled onto electronic parts, immediately unplug the machine and contact your local Antari dealer for advice.
- No user serviceable and modifiable parts inside. Never try to repair this product, an unauthorized technician may lead the machine to damage or malfunction.
- For adult use only. Children being supervised not to play with the machine. Never leave the machine running unattended.
- The machine is not to be used by persons (including children) with reduced physical, sensory or mental capabilities, or lack of experience and knowledge.

- Installed in a well ventilated area. Provide at least 50 cm space around the machine.
- Never add flammable liquid of any kind to the machine.
- Make sure there are no flammable materials close to the machine while operating.
- Only use Antari fluid. Other fluid may lead to heater clog and malfunction.
- If the machine fails to work, unplug the machine and stop operation immediately. Contact your local Antari dealer for .
- Before transporting the machine, make sure the fluid tank is completely drained.
- Smoke fluid may present health risks if swallowed. Do not drink smoke fluid. Store it securely. In case of eye contact or if fluid is swallowed immediately look for medical advice.

## Unpacking and Inspection

Open the shipping carton and verify that all equipment necessary to operate the system has arrived intact. If any shortage or damage due to transportation, please contact your Antari dealer and send back with original packaging for inspection. The shipping carton should contain the following items:

- DNG-250 Low Fog Generator
- Two power cords for connecting to Neutrik PowerCon connectors.
- 3M fog conducting hose
- User's manual (item 2-4 placed in the compartment on the top of the machine)
- Water collection tray (preinstalled in the machine)
- 3M PU tube, 6mmØ

## Setup

- The wheels at the bottom of the DNG-250 help to move the machine; wheel fixing mechanisms are located at the diagonal line. Position the machine at a spot, press down the fixing mechanism to prevent it from moving. To move the machine, press the opposite side of the fixing mechanism to release it. Please note that the machine is not allowed to place on a slope due to its big size. (refer to figure 1)



Figure

- Please aim the key on the PowerCon terminal of the power cord to the slot of the connector on the machine, plug it in and turn it about 10° clockwise until the power cord is completely fixed. The upper power cord is for the fog generator and the bottom one is for the compressor. (refer to figure 2 and 3)

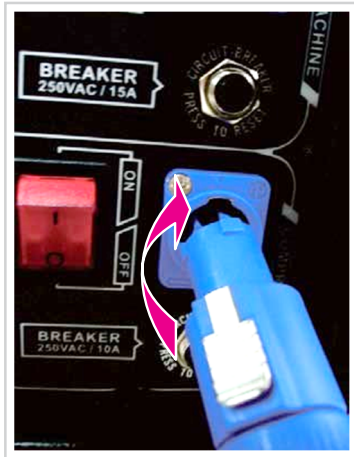

Figure



Figure

- Before connecting the machine to power supply, make sure to check the needed voltage and watt indicated on the metal plate of the machine.
- Connect the machine with the black fog conducting hose; it is a three-meter pipe. The length of the pipe can be adjusted to fit the actual need. (refer to figure 4)
- Fill Antari FLL Low Fog Effects Fluid to the tank, tighten the tank cap. (refer to figure 5)



Figure4



Figure5

## Operation

1. After confirming the voltage, connect the power cord to a grounded outlet then turn on the lower power switch and then the higher one. The warmup starts now, and the TFT touch panel will show the percentage of the whole warmup process until 100% that the warmup is completed.

2. TFT touch panel introduction :

2-1 Main Menu :

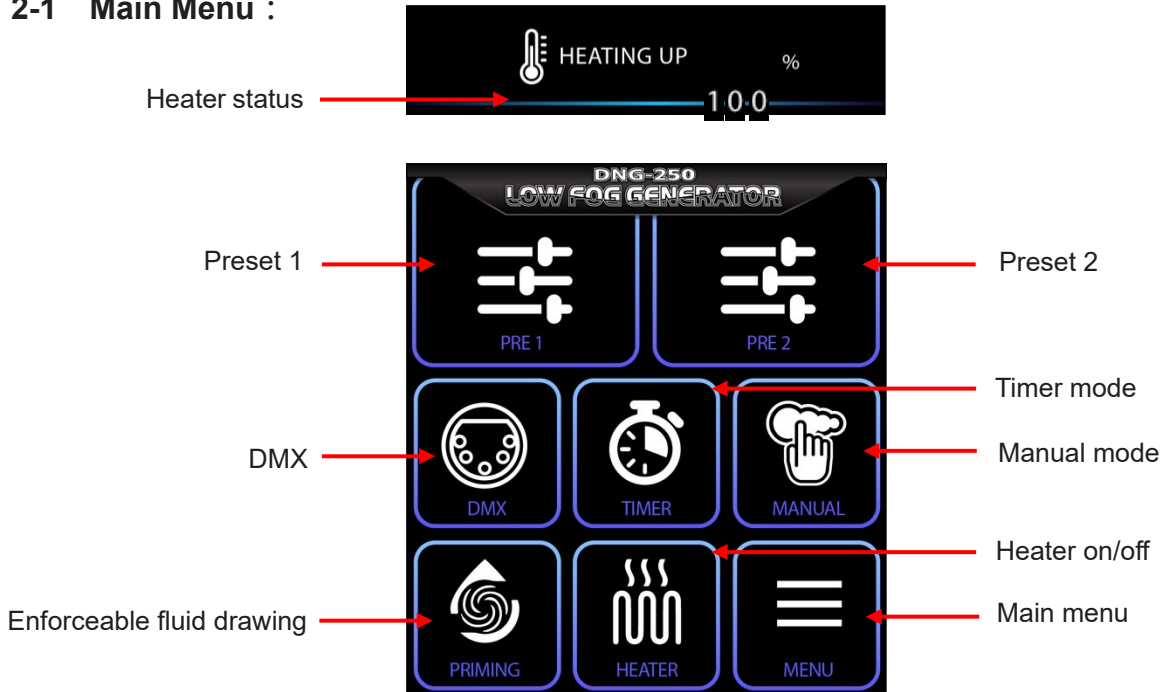

2-2  Manual mode :

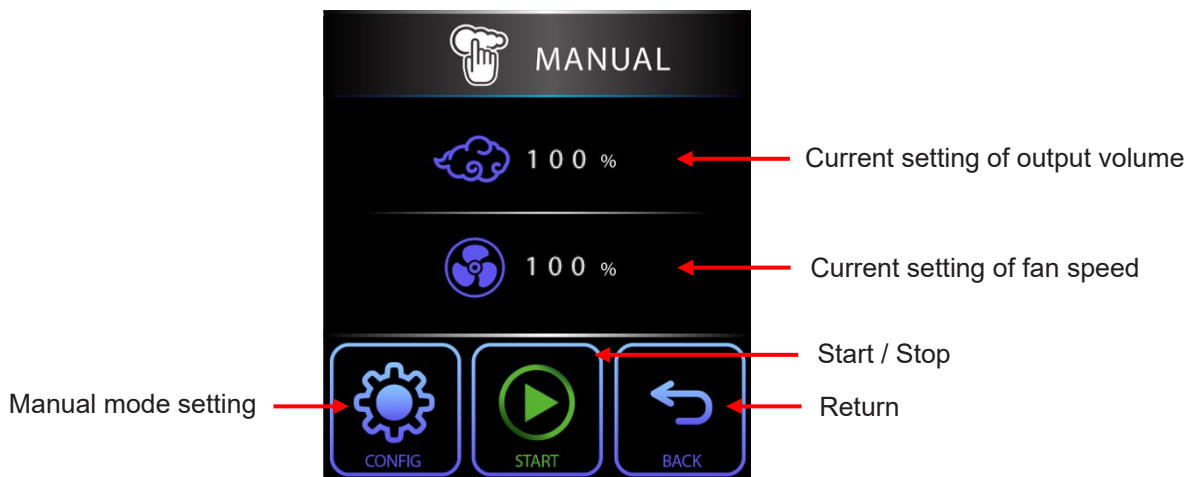

2-2-1  Manual mode setting :

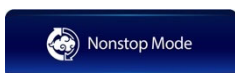

Continuous mode ON / OFF



Output volume 20% - 100%

### 2-3 Timer mode :

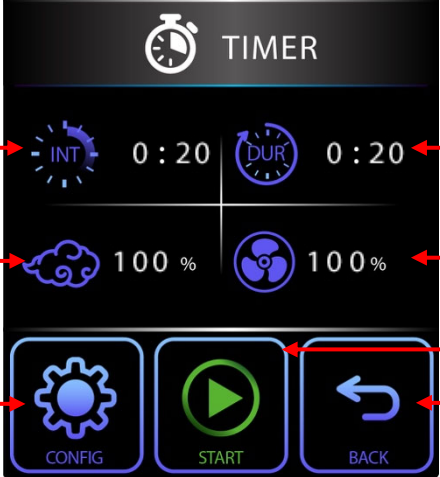

The screenshot shows the 'TIMER' control interface. It features a central display with four quadrants: 'INT' (interval time) set to 0:20, 'DUR' (duration time) set to 0:20, 'Output Level' (cloud icon) set to 100%, and 'Fan Speed' (fan icon) set to 100%. Below the display are three buttons: 'CONFIG' (gear icon), 'START' (play button icon), and 'BACK' (left arrow icon). Red arrows point from text labels to these elements.

Current setting of interval time →

Current setting of duration time →

Current setting of output volume →

Current setting of fan speed →

Start / Stop →

Return →

Timer mode setting →

### 2-3-1 Timer mode setting:



Interval 5 secs – 200 secs



Duration 5 secs – 200 secs



Continuous mode ON / OFF



Output volume 20% - 100%

### 2-4 DMX :

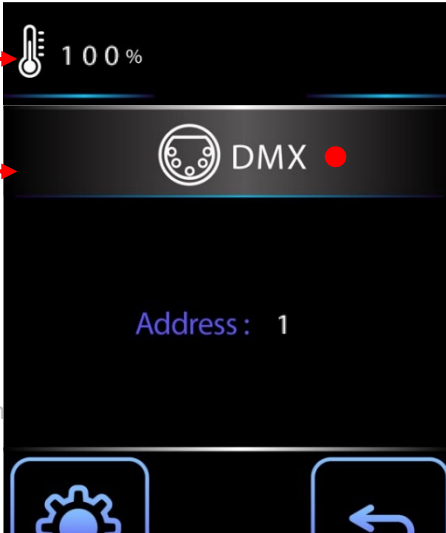

The screenshot shows the 'DMX' control interface. At the top, a thermometer icon indicates 'Heater temperature status' at 100%. Below this, a 'DMX' status indicator shows a red dot. The 'Address' is set to 1. At the bottom, there are 'CONFIG' (gear icon) and 'BACK' (left arrow icon) buttons. Red arrows point from text labels to these elements.

Heater temperature status →

DMX status →

DMX address: →

DMX setting → ← Return



2-4-1 DMX setting :

Address DMX address setting

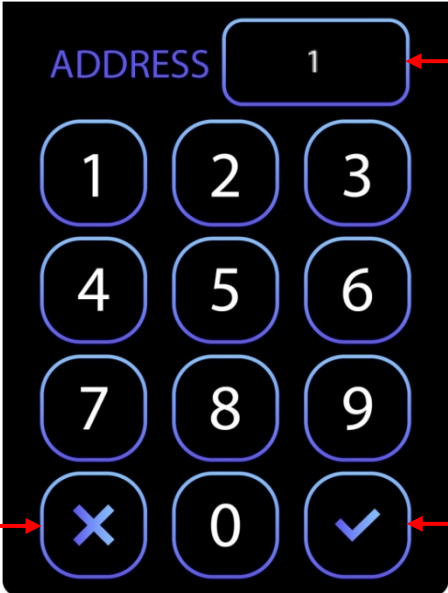

ADDRESS 1 ← Current address

Cancel → × 0 ✓ → Confirm

## 2-5 Enforceable fluid drawing:

When the tank is refilled with fog fluid, use this to draw the fluid. Press “Pause” once the output is back to avoid damp in fog. Default duration of the fluid drawing is 1 min.

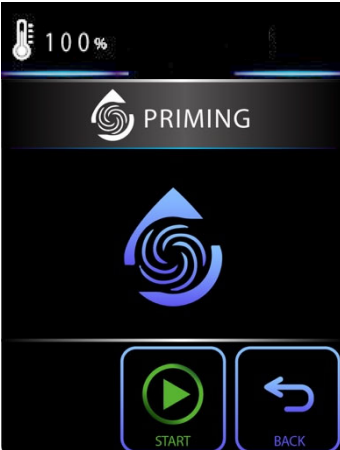

100% PRIMING

START BACK





100% PRIMING

0 1 : 0 0 ← Countdown

STOP BACK

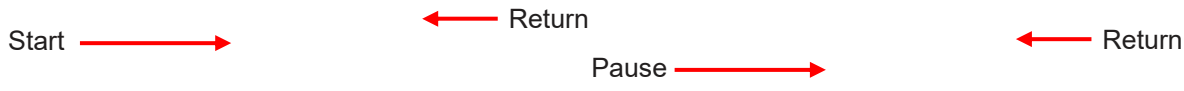





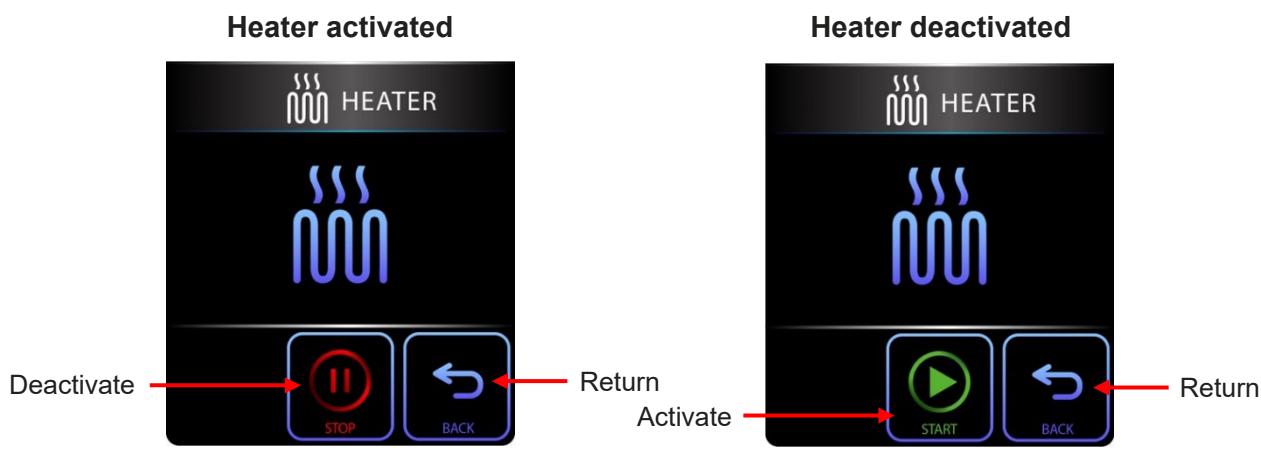



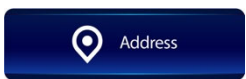



**2-6**  **Heater** : Heater can be activated or deactivated manually. Default setting is activated.



**2-7**  **Main menu :**

- 2-7-1**  **DMX setting**
-  DMX address setting. Please refer to page 8 for detail.
- 2-7-2**  **Basic information**
-  Software version
-  Operating Voltage Setting
-  Device Hour
- 2-7-3**  **Setting**

|   |  |
|---|--|
|  LCD Backlight   | LCD brightness (Low/Medium/High/Auto)<br>*LCD light will shut down in 1 min when “Auto” is selected. |
|  Auto Start      | Action before shut down will be automatically proceeded after warming up is finished.                |
|  Factory Reset   | Restore default setting.   |
|  Language        | Chinese/English  |
|  Software Update | Software update (for Antari’s distributors’ use only)  |

## DMX Connector Pin Assignment & instruction

- 3-1** The machine provide 3 or 5 pin XLR connector for DMX connection. Diagram below indicate pin assignment information.

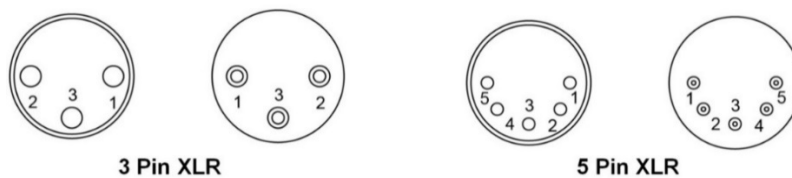

| Pin | Function  |
|-----|-----------|
| 1   | Grounding |
| 2   | Data -    |
| 3   | Data +    |

### 3-2 DNG-250 DMX instruction

DNG-250 low fog generator has built-in DMX 512 function with 3 Pin and 5 Pin sockets to choose from. After connecting to DMX, TFT touch panel can't be used, and all actions are controlled by DMX. Only DMX address can be entered with TFT touch panel.

### 3-3 DMX 512 settings

| Function      | Figures | Meaning  |
|---------------|---------|----------|
| Output Volume | 0 - 4   | Off      |
|               | 5 - 255 | 1 - 100% |

## RDM Function

### 4-1 RDM (Remote Device Management) Function

DNG-250 is equipped with RDM function which allows users to control the unit through devices with RDM ANSI E1.20 protocol. This is a protocol enhancement that allows bi-directional communication between a controller and attached RDM compliant devices over a standard DMX line. Users may set, monitor and manage the RDM supported devices and equipment in DMX network.

## 4-2 RDM Directory

| RDM PID                     | Value  | GET Allowed | SET Allowed |
|-----------------------------|--------|-------------|-------------|
| DISC_UNIQUE_BRANCH          | 0x0001 |             |             |
| DISC_MUTE                   | 0x0002 |             |             |
| DISC_UN_MUTE                | 0x0003 |             |             |
| STATUS_MESSAGE              | 0x0030 | O           |             |
| SUPPORTED_PARAMETERS        | 0x0050 | O           |             |
| *PARAMETER_DESCRIPTION      | 0x0051 | O           |             |
| DEVICE_INFO                 | 0x0060 | O           |             |
| PRODUCT_DETAIL_ID_LIST      | 0x0070 | O           |             |
| DEVICE_MODEL_DESCRIPTION    | 0x0080 | O           |             |
| MANUFACTURER_LABEL          | 0x0081 | O           |             |
| DEVICE_LABEL                | 0x0082 | O           | O           |
| LANGUAGE_CAPABILITIES       | 0x00A0 | O           |             |
| LANGUAGE                    | 0x00B0 | O           | O           |
| SOFTWARE_VERSION_LABEL      | 0x00C0 | O           |             |
| DMX_PERSONALITY             | 0x00E0 | O           | O           |
| DMX_PERSONALITY_DESCRIPTION | 0x00E1 | O           |             |
| DMX_START_ADDRESS           | 0x00F0 | O           | O           |
| SENSOR_DEFINITION           | 0x0200 | O           |             |
| SENSOR_VALUE                | 0x0201 | O           |             |
| DEVICE_HOURS                | 0x0400 | O           |             |
| IDENTIFY_DEVICE             | 0x1000 | O           | O           |

### Other important notes

- 5-1** A water collection tray is equipped at the rear of DNG-250. When the compressor is running for condensed fog, some water drops will flow into the tray. Please check the water level of the tray routinely and drain it on time to prevent overflow. (refer to figure 6).
- 5-2** If the machine is to be used for a long time or the water drops cannot be checked momentarily, the water collection tray can be removed and a 6 mm PU hose can be connected to the water draining hole located at the top of the water collection tank to directly drain out the water drops. After completing the draining, push up the upper red button to remove the hose. (refer to figure 7)



Figure 6

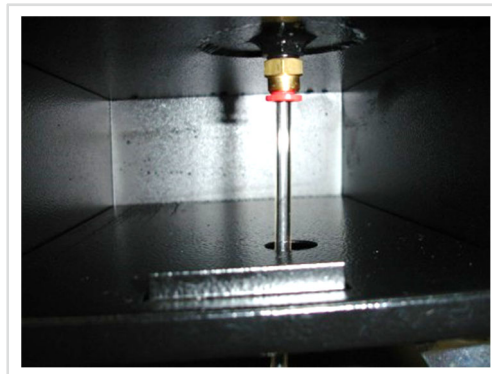

Figure 7

- 5-3** A black square metal mesh is located at the back of the machine. This is the air inlet of the fan. Please do not block the inlet and clean it routinely to keep the cleanness.
- 5-4** If the fog volume is too low, the machine generates noise during operation or the fog cannot be smoothly sprayed, please turn off the power immediately and check if the fog fluid is sufficient, whether the external fuse, controller connection or power supply has any problem. If none of the above shows any problem, insert the power plug again. If the machine still cannot normally operate, please check whether the hose connecting to the fog fluid tank is blocked, and if any fluid is flowing. If the cause cannot be identified, please do not allow the machine to operate to avoid damage. Turn off the machine Immediately and let it cool down. Please contact an Antari dealer or a designated service center. Do not disassemble the machine by yourself.
- 5-5** After using the DNG-250 for a long time, there may be residue on the floor which could be a possible cause of danger. Please note the material of the floor and pay special attention to the safety of persons walking on it.

- 5-6** The DNG-250 Low Fog Generator does not use dry ice. It is very environmental friendly and safe. However, the output fog is easily to be blown away by wind. Please note the air flow's impact from fan or air conditioner.

## Maintenance of the Machine

- 6-1** Cleaning your fog machine regularly will help reduce costly replacement and repair charges.
- 6-2** Do not allow the fog fluid to become contaminated. The cap should be on the tank at all times.
- 6-3** Prior to storing the machine for a longer period, clean it and drain all fog fluid from the tank. Disconnect and store the fog pipe and power cord. Store the machine and all parts into the parts tank located at front of the machine. Warm up the machine once a month, to protect it from moisture.
- 6-4** Store the machine cool and dry.

## Technical Specifications

|                        |   |
|------------------------|---|
| - Input voltage        | EU model: AC 220-240V, 50 / 60Hz 3.8~6.5A         |
| - Refrigerant          | R-404A · 1.76lb (0.8 kg)                          |
| - Start current        |   |
| - Rated power          | 240V / 36.1A                                      |
| - Warm-up time         | 240V / 1600W                                      |
| - Fluid consumption    | 240V / 8 mins (approx.)                           |
| - Fluid tank capacity  | 100 ml / min (100% output)                        |
| - Compatible fluid     | 10L (2.64gal)                                     |
| - Ambient temp. range  | Antari FLL-10 Low Fog Fluid                       |
| - Output               | 5°C ~ 40°C (41°F ~ 104°F)                         |
| - Control              | 120 m <sup>2</sup> / min<br>Manual and Timer Mode |
| - DMX Channels         | DMX 512   |
| - Optional Accessories | 1 channel   |
| - Dimensions           | FDNG-250 Flight Case                              |
| - Weight               | L 780 W 608 H 715 mm<br>130 kgs (286.60 lbs)      |