



A9910035 Play-V Receiver 1x8A CV 1-channel Constant Voltage PWM-dimmer

- Controlled by A9915800 Play-V RF Controller
- Each Receiver is addressable to Controller-Button 1-5
- Controlling ON/OFF & Dimming

Technical Specifications:

Input/Output Power: 12V-36V DC

Max. load: 1x8A

1x 96W@12V

1x 192W@24V

1x 288W@36V

Operation Frequency: 868Mhz

Range: 10-15 mtr

Ta: -20° - +50°

Tc: +75°

Dimension L x W x H (mm): 101 (88) x 38 x 20

Weight: 0.04 Kg

Protection: IP-20 Class II

Approvals: CE / FCC / RoHS

Dimensions in mm:

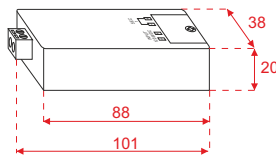

A9910035 RF Receiver

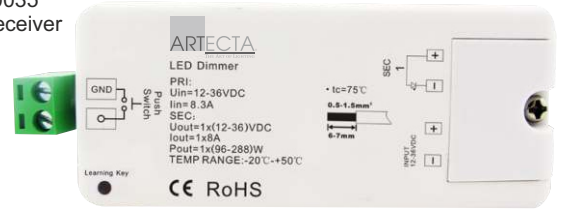

A dimmable by
any momentary switch
(order separately)

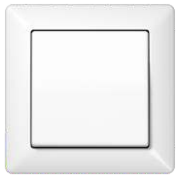

B dimmable by 1-ch.
RF-controlled dimmer (battery-powered)
(A9910050 order separately)

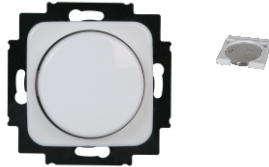

C dimmable by 5-ch. RF Control
(A9915800 order separately)

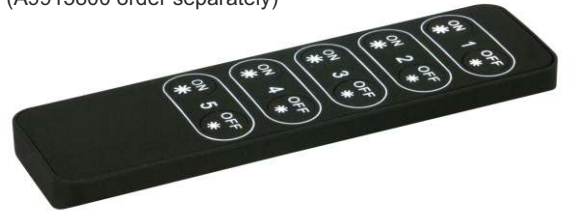

A dimmable by any momentary switch
(order separately)

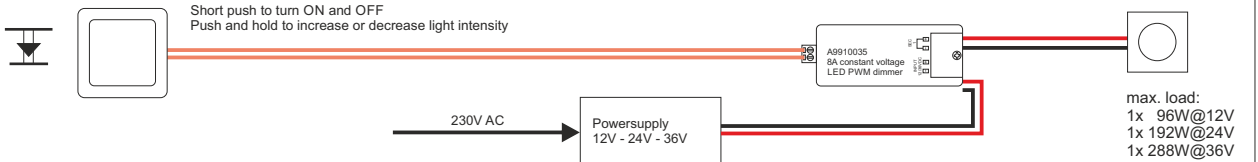

B dimmable by RF-control A9910050
(order separately)

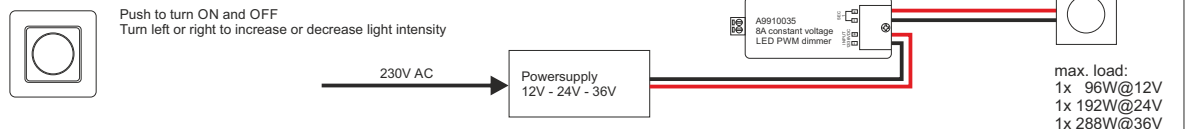

C dimmable by RF-control A9915800
(order separately)

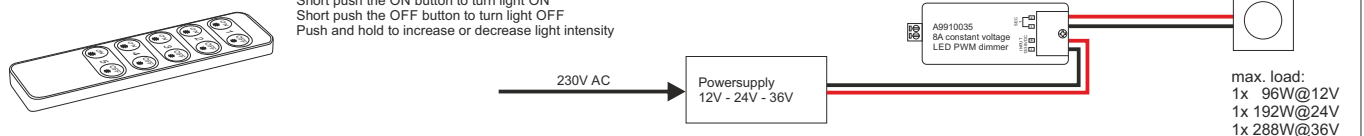

A dimmable by momentary switch

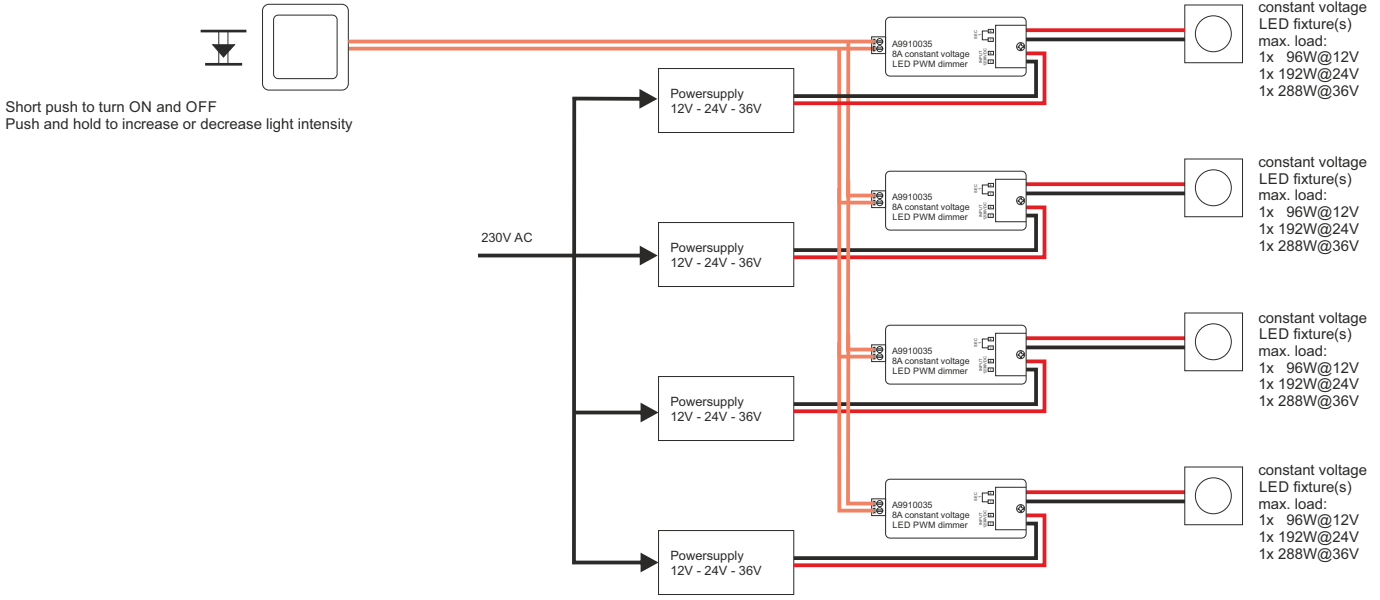

B dimmable by wireless RF-control A9910050

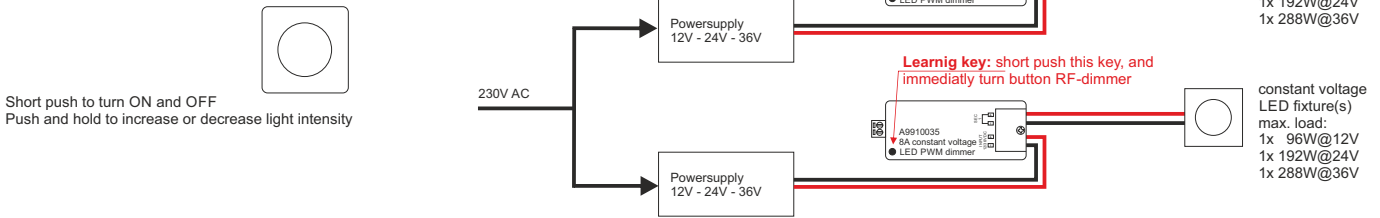

C dimmable by wireless RF-control A9915800

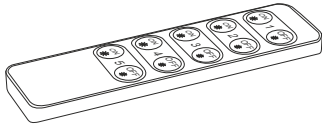

It's possible to control 5 groups of LED drivers by one wireless RF-control A9915800 (max distance controller/drivers: 10 meter)

Turn ON a group of LED's by short pushing the ON button (1-5)
Turn OFF a group of LED's by short pushing the OFF button (1-5)
Push and hold the ON button (1-5) to decrease light intensity
Push and hold the OFF button (1-5) to increase light intensity

