

Xi-5

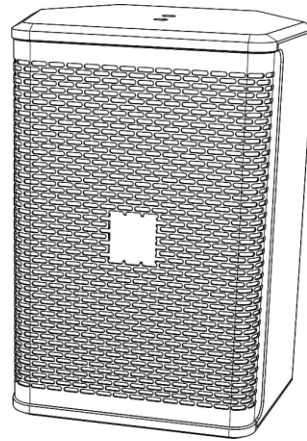

Xi-6

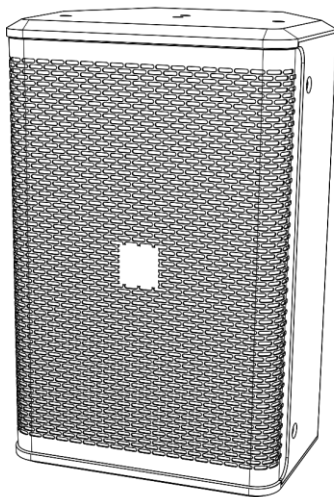

Xi-8

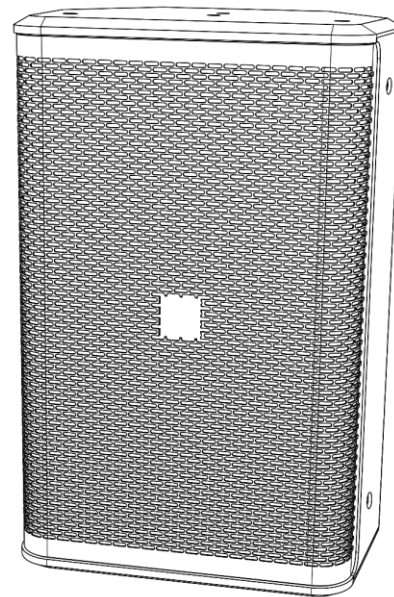

Xi-10

ENGLISH

# Xi Series

V1

Ordercode:	D3540/D3541	D3542/D3543	D3544/D3545	D3546/D3547
Product name:	Xi-5	Xi-6	Xi-8	Xi-10

**Table of contents**

---

**Warning** .....2  
    Safety Instructions .....3  
    Operating Determinations .....4  
    Return Procedure .....5  
    Claims.....5

**Description of the device**.....6  
    Overview .....7  
    Back.....8

**Installation**.....8  
    Installation of the Phoenix Terminal Connector .....8

**Setup and Operation** .....9  
    Speakon Connection Examples .....9  
        Xi-5/Xi-6 Setup.....9  
        Xi-8/Xi-10 Setup.....10  
    Phoenix Terminal Connection Examples .....11  
        Xi-5/Xi-6 Setup.....11  
        Xi-8/Xi-10 Setup.....12

**Maintenance** .....13



**Troubleshooting** .....13  
    No Sound .....13  
    Sound Warping.....13

**Product Specifications** .....14

**Dimensions**.....15

**Notes** .....16

## Warning

 For your own safety, please read this user manual carefully before your initial start-up! 

### Unpacking Instructions

Immediately upon receiving this product, carefully unpack the carton and check the contents to ensure that all parts are present, and have been received in good condition. Notify the dealer immediately and retain packing material for inspection if any parts appear damaged from shipping or the carton itself shows signs of mishandling. Save the carton and all packing materials. In the event that a device must be returned to the factory, it is important that the device be returned in the original factory box and packing.

### Your shipment includes:

- DAP Audio Xi-5/6/8/10
- User manual

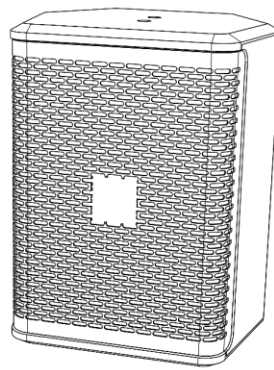

Xi-5

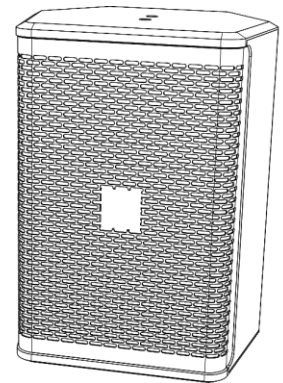

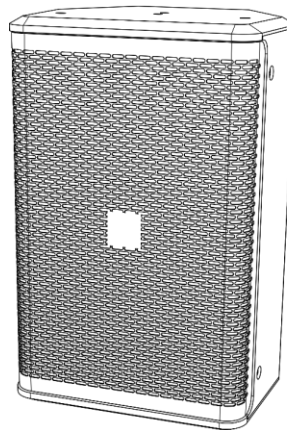

Xi-6

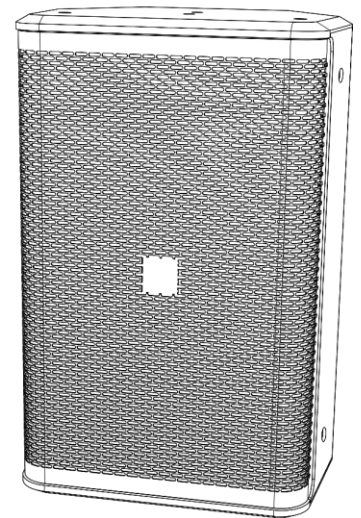

Xi-8



Xi-10

 **CAUTION!** Keep this device away from rain and moisture! Unplug mains lead before opening the housing! 

## Safety Instructions

Every person involved with the installation, operation and maintenance of this system has to:

- be qualified
- follow the instructions of this manual

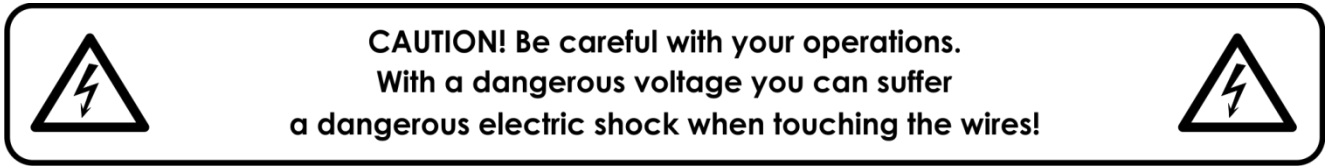

Before the initial start-up, please make sure that there is no damage caused by transportation. Should there be any, consult your dealer and do not use the system.

To maintain perfect condition and to ensure a safe operation, it is absolutely necessary for the user to follow the safety instructions and warning notes written in this manual.

Please consider that damages caused by manual modifications to the system are not subject to warranty.

This system contains no user-serviceable parts. Refer servicing to qualified technicians only.

### IMPORTANT:

The manufacturer will not accept liability for any resulting damages caused by the non-observance of this manual or any unauthorized modification to the system.

- Never remove warning or informative labels from the device.
- Never leave any cables lying around.
- Do not open the device and do not modify the device.
- Do not set the input signal level higher than required to drive the equipment to full output.
- Only use system indoors, avoid contact with water or other liquids.
- Avoid flames and do not put close to flammable liquids or gases.
- Make sure you do not use the wrong kind of cables or defective cables.
- Extreme frequency boosts in connection with a high input signal level may lead to overdriving your equipment. Should this occur, it is necessary to reduce the input signal level.
- If system is dropped or struck, disconnect the power supply immediately. Have a qualified engineer inspect for safety before operating.
- If the system has been exposed to drastic temperature fluctuation (e.g. after transportation), do not switch it on immediately. The arising condensation water might damage your system. Leave the system switched off until it has reached room temperature.
- If your DAP Audio device fails to work properly, discontinue use immediately. Pack the device securely (preferably in the original packing material), and return it to your DAP Audio dealer for service.
- Repairs, servicing and electric connection must be carried out by a qualified technician.
- Keep this manual for future reference.
- Clean only with dry cloth.
- Do not connect the speaker to the mains power; doing so will damage the speaker.
- Take care of your speaker wires, they should be free of damage. Damaged speaker wires might result in poor sound quality and can damage amplifiers.
- This device should only be serviced by qualified personnel. If not, warranty might be void.
- Use cable of the right gauge, certainly for long runs.
- Use cables with clear color indication and maintain polarity throughout the whole system.
- Avoid loud feedback from microphones because it can damage your speaker.
- Please check the device's condition after unpacking. If the outside of the carton box has been damaged, inform your shipper immediately.

### Operating Determinations

If this system is operated in any other way, than the one described in this manual, the product may suffer damages and the warranty becomes void.

Any other operation may lead to dangers like short-circuit, burns, electric shock, etc.

*You endanger your own safety and the safety of others!*

*Improper installation can cause serious injuries and damage of property !*

- D3422HB** – Hanging bracket for Xi-5 (black)
- D3422WHB** – Hanging bracket for Xi-5 (white)
- D3423HB** – Hanging bracket for Xi-6 (black)
- D3423WHB** – Hanging bracket for Xi-6 (white)
- D3424HB** – Hanging bracket for Xi-8 (black)
- D3424WHB** – Hanging bracket for Xi-8 (white)
- D3425HB** – Hanging bracket for Xi-10 (black)
- D3425WHB** – Hanging bracket for Xi-10 (white)

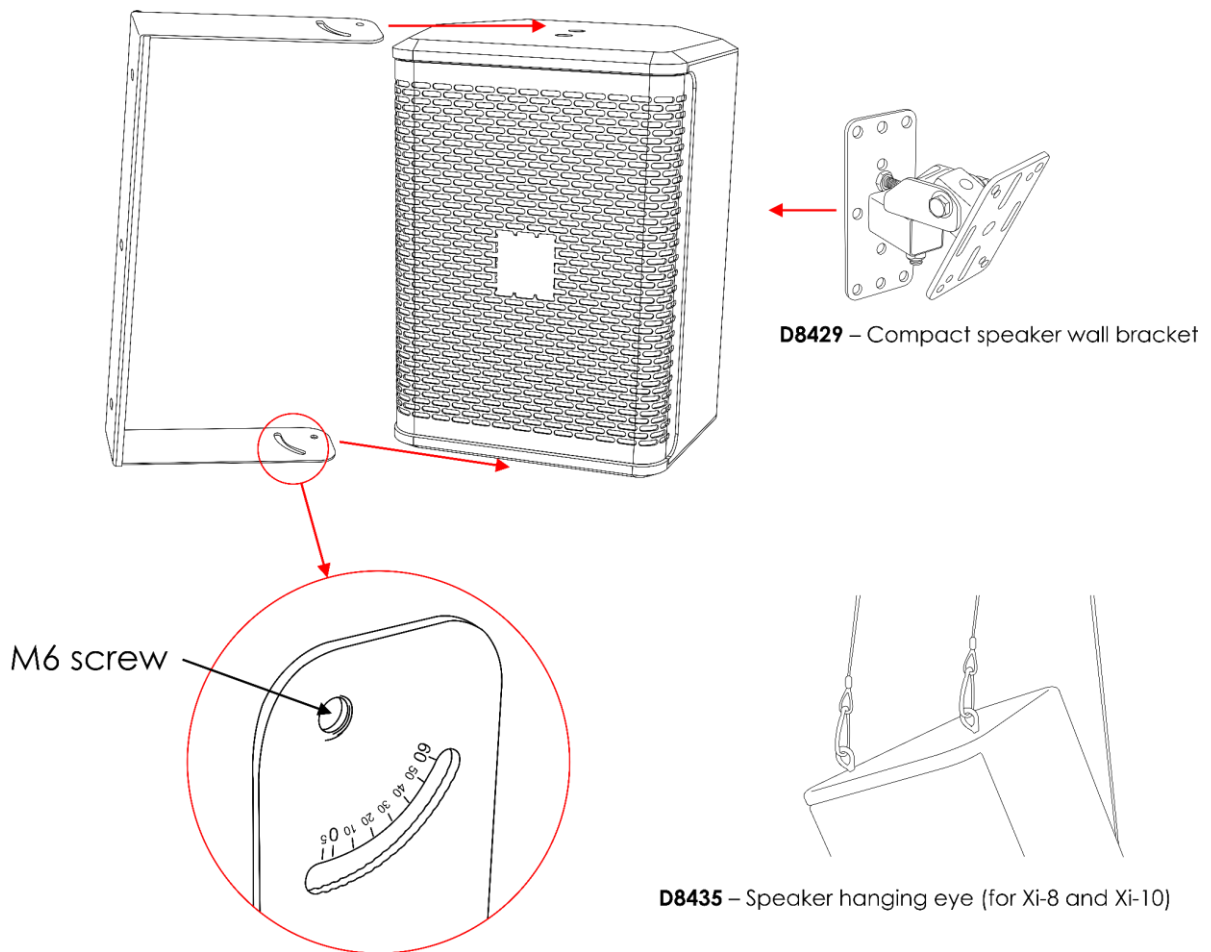

The Xi speakers can be placed on a flat stage floor or mounted to any kind of truss with the mounting brackets (**D3422HB/D3422WHB/D3423HB/D3423WHB/D3424HB/D3424WHB/D3425HB/D3425WHB**). They can also be mounted to a wall with the Compact speaker wall bracket (**D8429**). The Xi-8 and Xi-10 can be hung from a ceiling with the Speaker hanging eye (**D8435**).

*Refer installation to a qualified technician! Do not attempt installation yourself!*





## Return Procedure



Returned merchandise must be sent prepaid and in the original packing, call tags will not be issued. Package must be clearly labeled with a Return Authorization Number (RMA number). Products returned without an RMA number will be refused. Highlite will not accept the returned goods or any responsibility. Call Highlite 0031-455667723 or mail [aftersales@highlite.com](mailto:aftersales@highlite.com) and request an RMA prior to shipping the device. Be prepared to provide the model number, serial number and a brief description of the cause for the return. Be sure to properly pack device, any shipping damage resulting from inadequate packaging is the customer's responsibility. Highlite reserves the right to use its own discretion to repair or replace product(s). As a suggestion, proper UPS packing or double-boxing is always a safe method to use.

**Note: If you are given an RMA number, please include the following information on a piece of paper inside the box:**

- 01) Your name
- 02) Your address
- 03) Your phone number
- 04) A brief description of the symptoms

## Claims

The client has the obligation to check the delivered goods immediately upon delivery for any shortcomings and/or visible defects, or perform this check after our announcement that the goods are at their disposal. Damage incurred in shipping is the responsibility of the shipper; therefore the damage must be reported to the carrier upon receipt of merchandise.

It is the customer's responsibility to notify and submit claims with the shipper in the event that a device is damaged due to shipping. Transportation damage has to be reported to us within one day after receipt of the delivery.

Any return shipment has to be made post-paid at all times. Return shipments must be accompanied with a letter defining the reason for return shipment. Non-prepaid return shipments will be refused, unless otherwise agreed in writing.

Complaints against us must be made known in writing or by fax within 10 working days after receipt of the invoice. After this period complaints will not be handled anymore.

Complaints will only then be considered if the client has so far complied with all parts of the agreement, regardless of the agreement of which the obligation is resulting.

## Description of the device

### Features

The Xi series is a loudspeaker range for fixed audio installations. The series uses a Celestion HF Driver which extensively enhances the sound performance of the device. The Xi offers versatile installation possibilities: optional U-shape brackets, screw threads for the use of flying eyes or wall mount brackets.

The Xi-5 and Xi-6 are 16  $\Omega$  devices, capable of accommodating larger installations. The Xi-8 and Xi-10 have rotatable horns, which allows both horizontal and vertical movement. The Xi is suitable for indoor venues, such as: restaurants, cafes, clubs, health centers, theme parks, hospitals.

#### Xi-5 (D3540/D3541)

- Speaker system: 2-way
- Continuous power: 125 W
- Program power: 250 W
- Peak power: 500 W
- Impedance: 16  $\Omega$
- Sensitivity W/m (full space): 93 dB
- Peak SPL @ 1 m (theoretical): 120 dB
- LF driver: 5,25"
- HF driver: 1" Celestion
- Dispersion (HxV): 90° x 60°
- Frequency response (-3 dB): 80–20000 Hz
- Frequency range (-10 dB): 60–20000 Hz
- Recommended high pass filter: 75 Hz, BW-24
- Mounting: M6 screw-threads for optional brackets
- Connections: Speakon IN/OUT; Phoenix connector (maximum cable gauge: 1,5 mm<sup>2</sup> / AWG: 12–24)
- Housing: Wood
- Grill material: Steel
- Color: Black (**D3540**), White (**D3541**)
- Dimensions: 225 x 200 x 275 mm (LxWxH)
- Weight: 5,06 kg

#### Xi-8 (D3544/D3545)

- Speaker system: 2-way
- Continuous power: 250 W
- Program power: 500 W
- Peak power: 1000 W
- Impedance: 8  $\Omega$
- Sensitivity W/m (full space): 95 dB
- Peak SPL @ 1 m (theoretical): 125 dB
- LF driver: 8"
- HF driver: 1" Celestion
- Dispersion (HxV): 90° x 60°
- Frequency response (-3 dB): 55–20000 Hz
- Frequency range (-10 dB): 55–20000 Hz
- Recommended high pass filter: 55 Hz, BW-24
- Mounting: M6 screw-threads for optional brackets  
M8 screw-threads for flying eyes
- Connections: Speakon IN/OUT; Phoenix connector (maximum cable gauge: 1,5 mm<sup>2</sup> / AWG: 12–24)
- Housing: Wood
- Grill material: Steel
- Color: Black (**D3544**), White (**D3545**)
- Dimensions: 290 x 260 x 430 mm (LxWxH)
- Weight: 10,26 kg

#### Xi-6 (D3542/D3543)

- Speaker system: 2-way
- Continuous power: 175 W
- Program power: 300 W
- Peak power: 700 W
- Impedance: 16  $\Omega$
- Sensitivity W/m (full space): 92 dB
- Peak SPL @ 1 m (theoretical): 122 dB
- LF driver: 6,5"
- HF driver: 1" Celestion
- Dispersion (HxV): 90° x 60°
- Frequency response (-3 dB): 80–20000 Hz
- Frequency range (-10 dB): 60–20000 Hz
- Recommended high pass filter: 75 Hz, BW-24
- Mounting: M6 screw-threads for optional brackets
- Connections: Speakon IN/OUT; Phoenix connector (maximum cable gauge: 1,5 mm<sup>2</sup> / AWG: 12–24)
- Housing: Wood
- Grill material: Steel
- Color: Black (**D3542**), White (**D3543**)
- Dimensions: 250 x 226 x 333 mm (LxWxH)
- Weight: 6,66 kg

#### Xi-10 (D3546/D3547)

- Speaker system: 2-way
- Continuous power: 300 W
- Program power: 600 W
- Peak power: 1200 W
- Impedance: 8  $\Omega$
- Sensitivity W/m (full space): 96 dB
- Peak SPL @ 1 m (theoretical): 127 dB
- LF driver: 10"
- HF driver: 1,4" Celestion
- Dispersion (HxV): 90° x 60°
- Frequency response (-3 dB): 45–18000 Hz
- Frequency range (-10 dB): 40–20000 Hz
- Recommended high pass filter: 40 Hz, BW-24
- Mounting: M6 screw-threads for optional brackets  
M8 screw-threads for flying eyes
- Connections: Speakon IN/OUT; Phoenix connector (maximum cable gauge: 1,5 mm<sup>2</sup> / AWG: 12–24)
- Housing: Wood
- Grill material: Steel
- Color: Black (**D3546**), White (**D3547**)
- Dimensions: 346 x 300 x 523 mm (LxWxH)
- Weight: 13,68 kg

**Optional accessories:**

- [D3422HB](#) – Hanging bracket for Xi-5 (black)
- [D3422WHB](#) – Hanging bracket for Xi-5 (white)
- [D3423HB](#) – Hanging bracket for Xi-6 (black)
- [D3423WHB](#) – Hanging bracket for Xi-6 (white)
- [D3424HB](#) – Hanging bracket for Xi-8 (black)
- [D3424WHB](#) – Hanging bracket for Xi-8 (white)
- [D3425HB](#) – Hanging bracket for Xi-10 (black)
- [D3425WHB](#) – Hanging bracket for Xi-10 (white)
- [D8429](#) – Compact speaker wall bracket
- [D8435](#) – Speaker hanging eye (for Xi-8 and Xi-10)

**Overview**

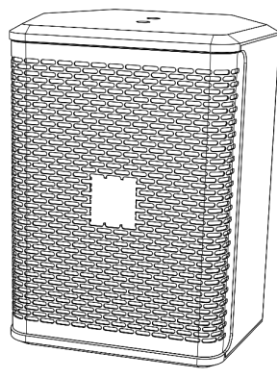

Xi-5

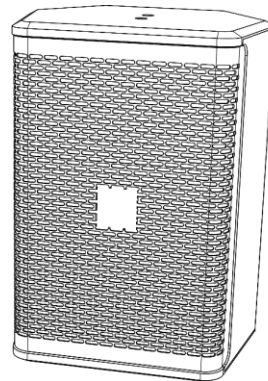

Xi-6

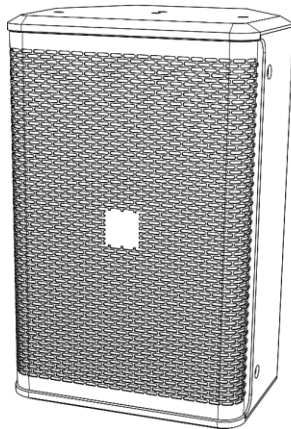

Xi-8

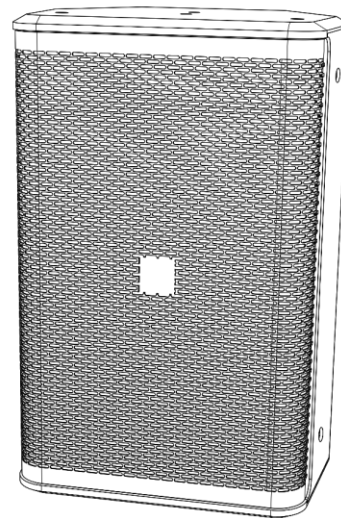

Xi-10

Fig. 01



## Back

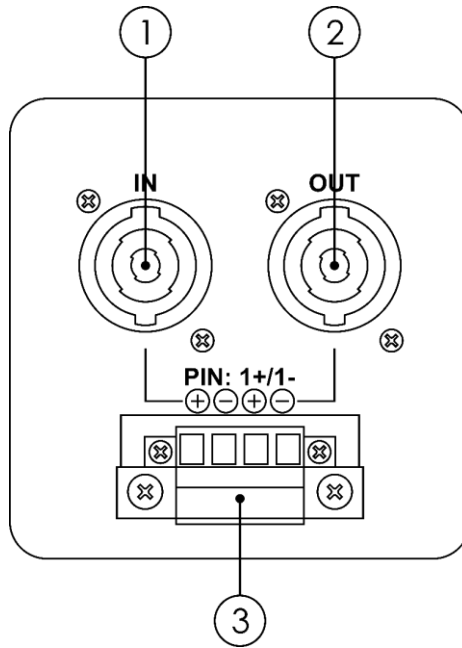

Fig. 02

- 01) Speakon connector IN
- 02) Speakon connector OUT
- 03) 4-pin Phoenix terminal connector

## Installation

Remove all packing materials from the Xi. Check that all foam and plastic padding is removed. Connect all cables.

**Always disconnect from electric mains power supply before cleaning or servicing.  
Damages caused by non-observance are not subject to warranty.**

### Installation of the Phoenix Terminal Connector

- 01) Loosen the 2 screws on the **4-pin Phoenix terminal power connector (03)**.
- 02) Remove the **4-pin Phoenix terminal power connector (03)**.
- 03) Connect an external device. Insert the cables correctly.

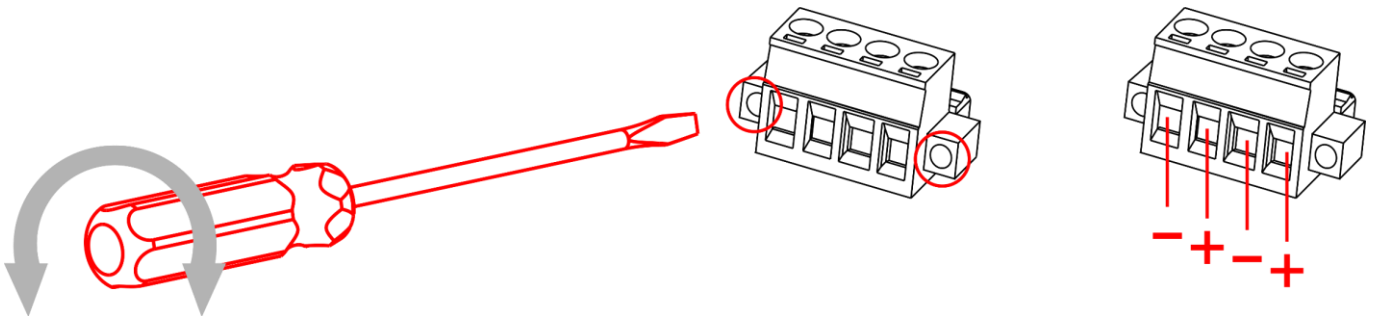

Fig. 03

- 04) Put the Phoenix connector back in the device.
- 05) Tighten the 2 screws on the **4-pin Phoenix terminal power connector (03)**.

## Setup and Operation

Before plugging the device in, always make sure that the power supply matches the product specification voltage.

- 01) Connect the devices to each other in one of the 2 ways:
  - With Speakon cables. See Fig. 04 and Fig. 05 on pages 9–10 for more information.
  - With Phoenix terminal connectors. See Fig. 06 and Fig. 07 on pages 11–12 for more information.
- 02) Connect your mixer to the amplifier.
- 03) Connect power supply to the mixer and the amplifier.

### Speakon Connection Examples

#### Xi-5/Xi-6 Setup

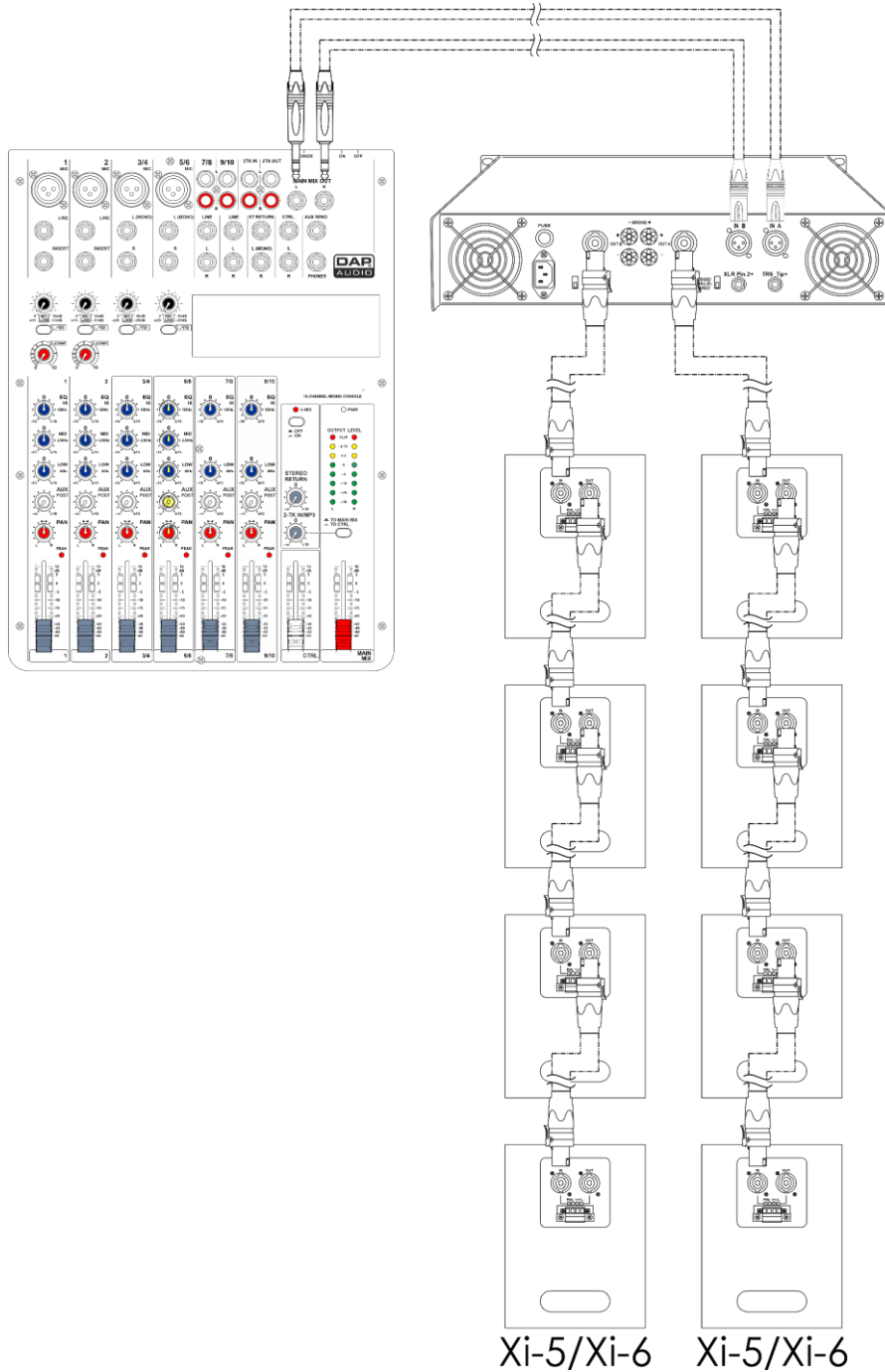
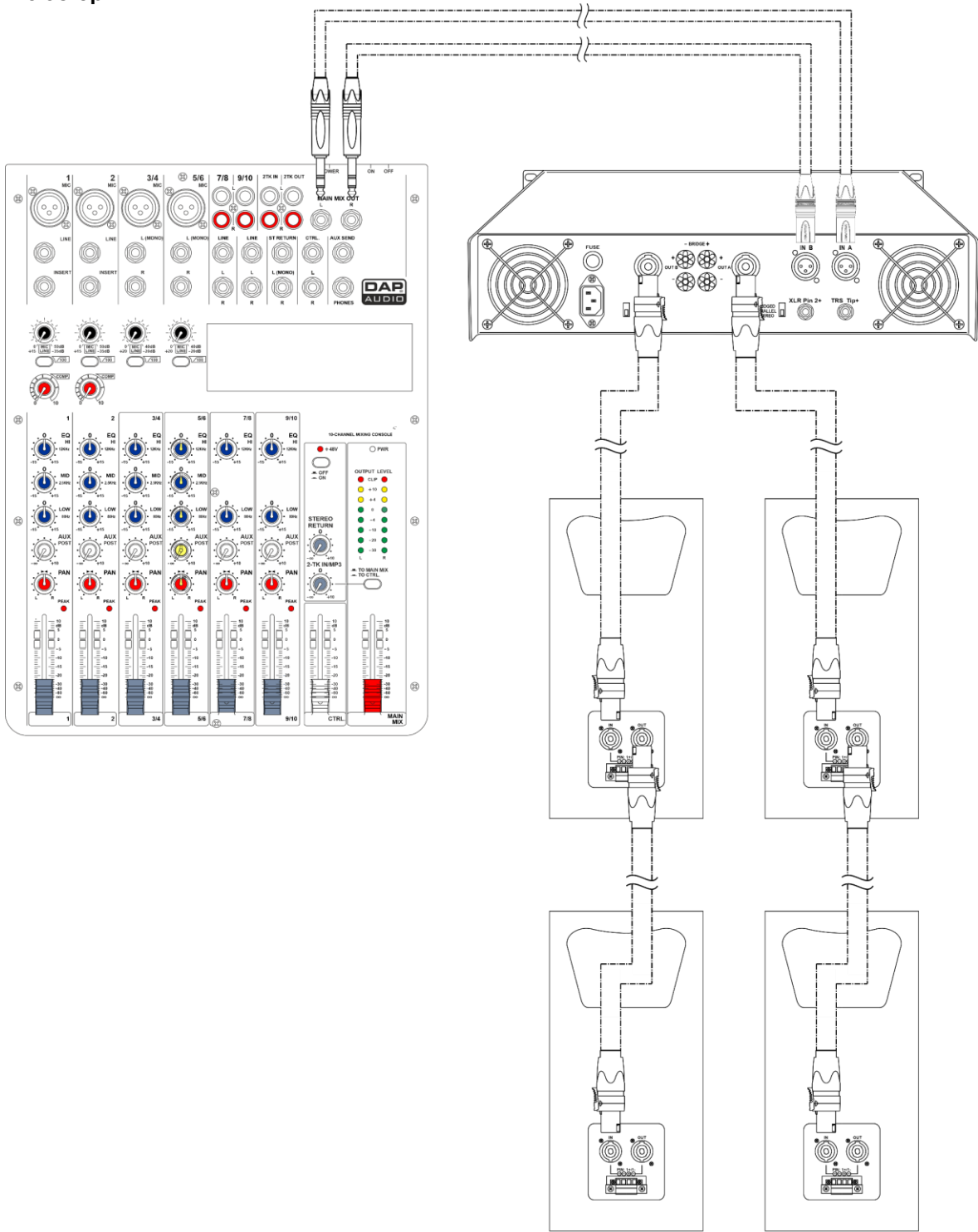

Fig. 04

Xi-8/Xi-10 Setup



Xi-8/Xi-10 Xi-8/Xi-10

Fig. 05

# Phoenix Terminal Connection Examples

## Xi-5/Xi-6 Setup

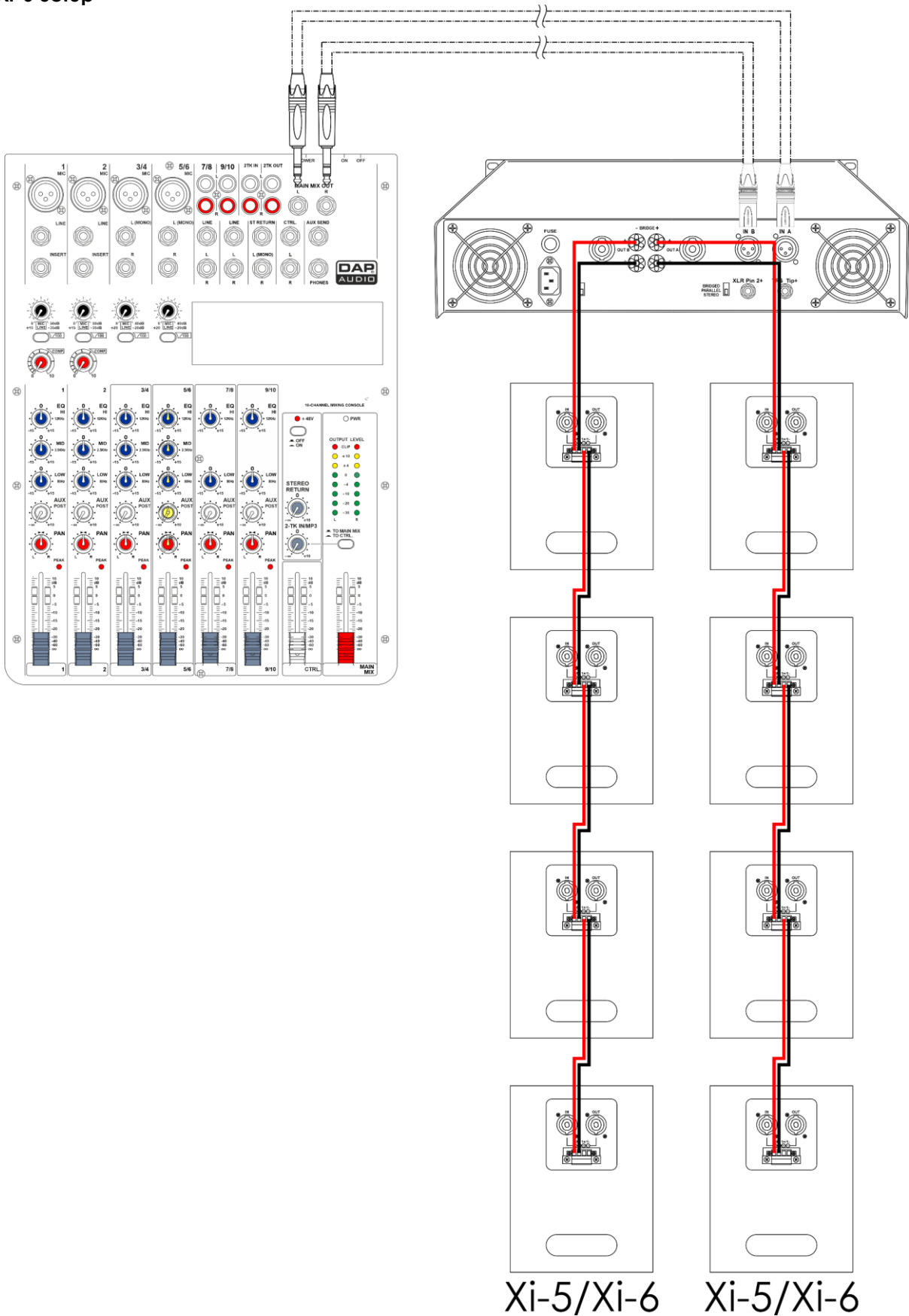
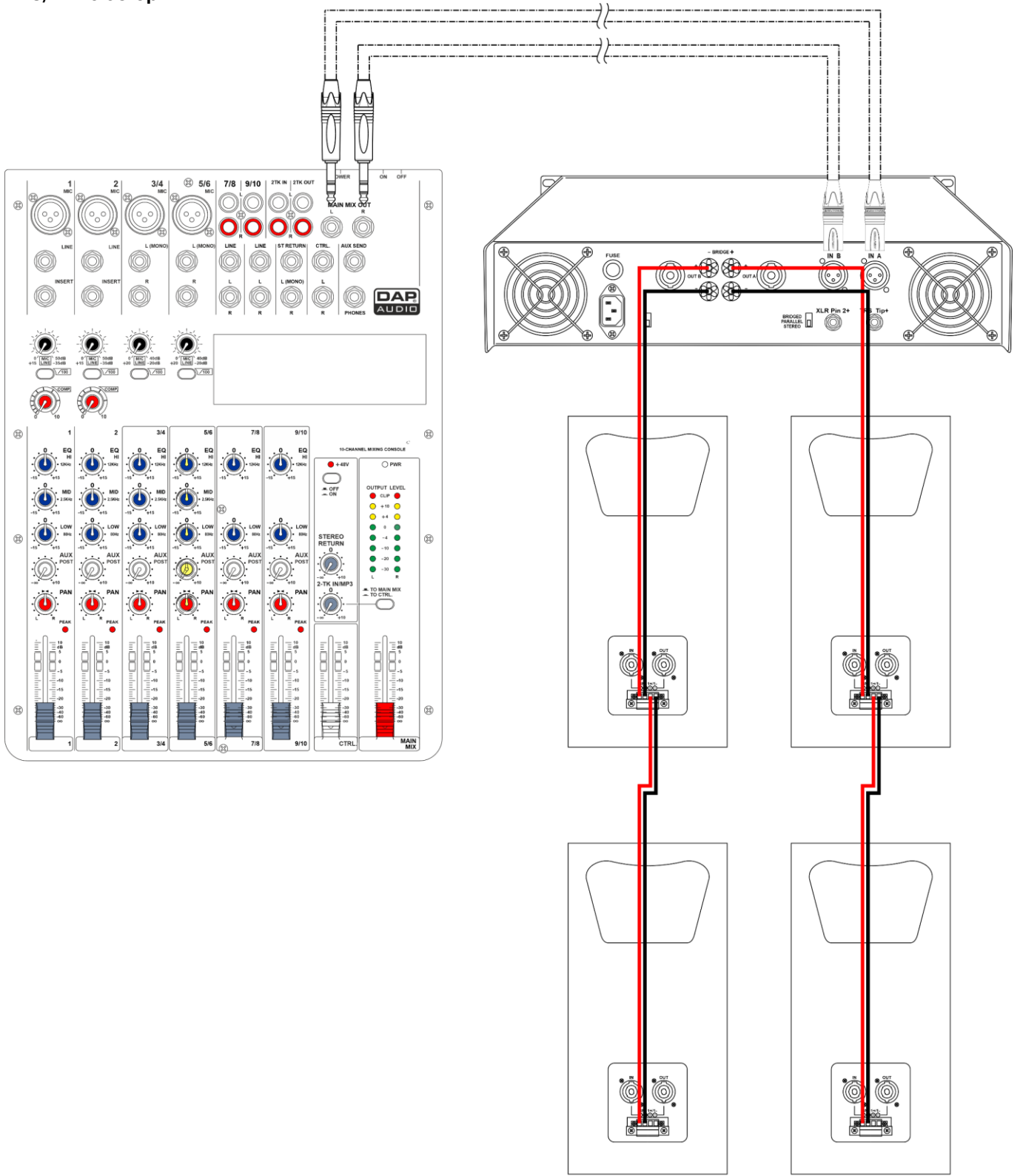

Fig. 06

Xi-8/Xi-10 Setup



Xi-8/Xi-10 Xi-8/Xi-10

Fig. 07



## Maintenance

---

The DAP Audio Xi requires almost no maintenance. However, you should keep the device clean. Disconnect the mains power supply, and then wipe the cover with a damp cloth. Do not immerse in liquid. Do not use alcohol or solvents.

Keep connections clean. Disconnect electric power, and then wipe the audio connections with a damp cloth. Make sure connections are thoroughly dry before linking equipment or supplying electric power.

## Troubleshooting

---

### No Sound

Always check if all the cables are connected. Always turn off power to the area before checking the wires, to prevent electric shock.

If everything works properly and there is still no sound, read the manufacturer's instructions again, to make sure they were followed during installation. If everything was installed correctly and there is still no sound, ask a technician to inspect your speaker.

If the speakers do not operate properly, refer servicing to a technician.

Suspect two potential problem areas as: the power supply and the speakers.

01) Power supply. Check if the device is plugged into an appropriate power supply.

02) The speakers. Return the Xi to your DAP Audio dealer.

03) If both appear to be O.K., plug the device in again.

04) If you are unable to determine the cause of the problem, do not open the Xi, as this may damage the device and the warranty will become void.

05) Return the device to your DAP Audio dealer.

### Sound Warping

If the sound coming out of your speaker is loud enough, but seems to be warped or distorted, you may need to adjust treble or bass levels.

If there are not many pieces of furniture in the room and the floor has no carpet or rug, then you will most likely have to set your treble to minus. With very little in the room to absorb the sound, too much treble can make the sound bounce off objects in the room, making it tinny sounding.

If the speaker is too close to a wall and is not aimed properly, set the bass to minus, to stop the low tones from bouncing off the walls or large pieces of furniture.

## Product Specifications

### Xi-5 (D3540/D3541)

- Speaker system: 2-way
- Continuous power: 125 W
- Program power: 250 W
- Peak power: 500 W
- Impedance: 16  $\Omega$
- Sensitivity W/m (full space): 93 dB
- Peak SPL @ 1 m (theoretical): 120 dB
- LF driver: 5,25"
- HF driver: 1" Celestion
- Dispersion (HxV): 90° x 60°
- Frequency response (-3 dB): 80–20000 Hz
- Frequency range (-10 dB): 60–20000 Hz
- Recommended high pass filter: 75 Hz, BW-24
- Mounting: M6 screw-threads for optional brackets
- Connections: Speakon IN/OUT; Phoenix connector (maximum cable gauge: 1,5 mm<sup>2</sup> / AWG: 12–24)
- Housing: Wood
- Grill material: Steel
- Color: Black (**D3540**), White (**D3541**)
- Dimensions: 225 x 200 x 275 mm (LxWxH)
- Weight: 5,06 kg

### Xi-8 (D3544/D3545)

- Speaker system: 2-way
- Continuous power: 250 W
- Program power: 500 W
- Peak power: 1000 W
- Impedance: 8  $\Omega$
- Sensitivity W/m (full space): 95 dB
- Peak SPL @ 1 m (theoretical): 125 dB
- LF driver: 8"
- HF driver: 1" Celestion
- Dispersion (HxV): 90° x 60°
- Frequency response (-3 dB): 55–20000 Hz
- Frequency range (-10 dB): 55–20000 Hz
- Recommended high pass filter: 55 Hz, BW-24
- Mounting: M6 screw-threads for optional brackets  
M8 screw-threads for flying eyes
- Connections: Speakon IN/OUT; Phoenix connector (maximum cable gauge: 1,5 mm<sup>2</sup> / AWG: 12–24)
- Housing: Wood
- Grill material: Steel
- Color: Black (**D3544**), White (**D3545**)
- Dimensions: 290 x 260 x 430 mm (LxWxH)
- Weight: 10,26 kg

### Xi-6 (D3542/D3543)

- Speaker system: 2-way
- Continuous power: 175 W
- Program power: 300 W
- Peak power: 700 W
- Impedance: 16  $\Omega$
- Sensitivity W/m (full space): 92 dB
- Peak SPL @ 1 m (theoretical): 122 dB
- LF driver: 6,5"
- HF driver: 1" Celestion
- Dispersion (HxV): 90° x 60°
- Frequency response (-3 dB): 80–20000 Hz
- Frequency range (-10 dB): 60–20000 Hz
- Recommended high pass filter: 75 Hz, BW-24
- Mounting: M6 screw-threads for optional brackets
- Connections: Speakon IN/OUT; Phoenix connector (maximum cable gauge: 1,5 mm<sup>2</sup> / AWG: 12–24)
- Housing: Wood
- Grill material: Steel
- Color: Black (**D3542**), White (**D3543**)
- Dimensions: 250 x 226 x 333 mm (LxWxH)
- Weight: 6,66 kg

### Xi-10 (D3546/D3547)

- Speaker system: 2-way
- Continuous power: 300 W
- Program power: 600 W
- Peak power: 1200 W
- Impedance: 8  $\Omega$
- Sensitivity W/m (full space): 96 dB
- Peak SPL @ 1 m (theoretical): 127 dB
- LF driver: 10"
- HF driver: 1,4" Celestion
- Dispersion (HxV): 90° x 60°
- Frequency response (-3 dB): 45–18000 Hz
- Frequency range (-10 dB): 40–20000 Hz
- Recommended high pass filter: 40 Hz, BW-24
- Mounting: M6 screw-threads for optional brackets  
M8 screw-threads for flying eyes
- Connections: Speakon IN/OUT; Phoenix connector (maximum cable gauge: 1,5 mm<sup>2</sup> / AWG: 12–24)
- Housing: Wood
- Grill material: Steel
- Color: Black (**D3546**), White (**D3547**)
- Dimensions: 346 x 300 x 523 mm (LxWxH)
- Weight: 13,68 kg

Design and product specifications are subject to change without prior notice.



Website: [www.Dap-audio.info](http://www.Dap-audio.info)  
Email: [service@highlite.com](mailto:service@highlite.com)

## Dimensions

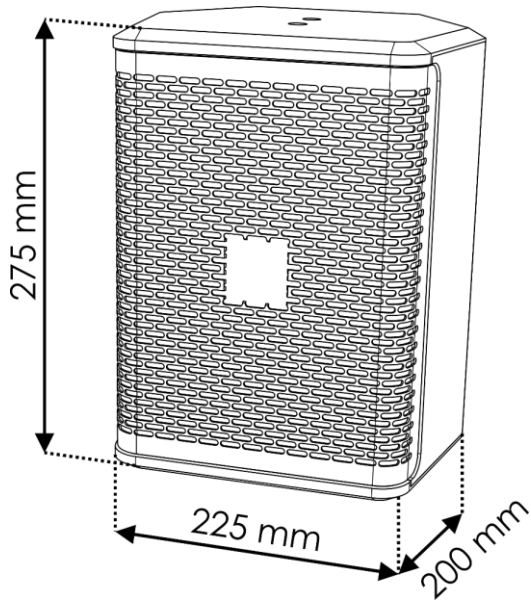

D3540/D3541 - Xi-5

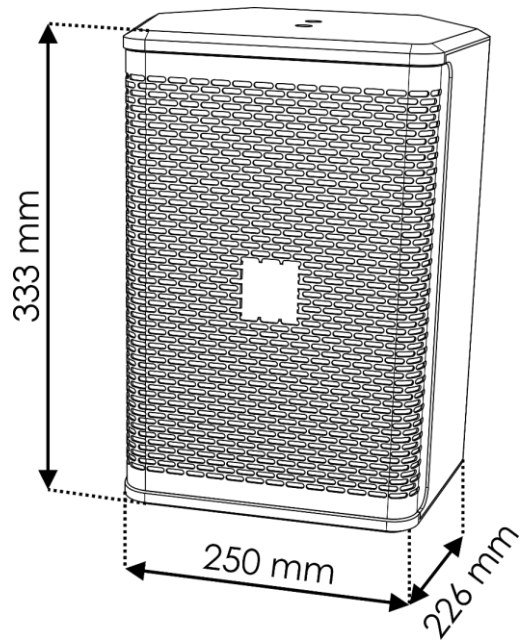

D3542/D3543 - Xi-6

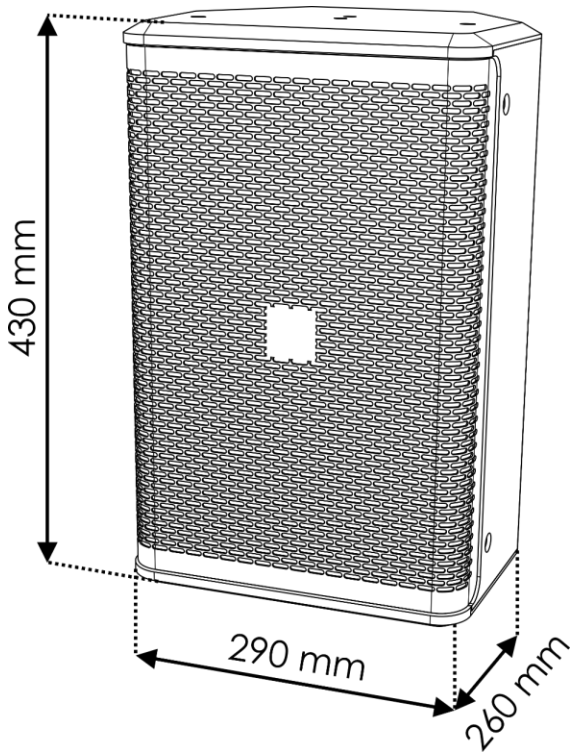

D3544/D3545 - Xi-8

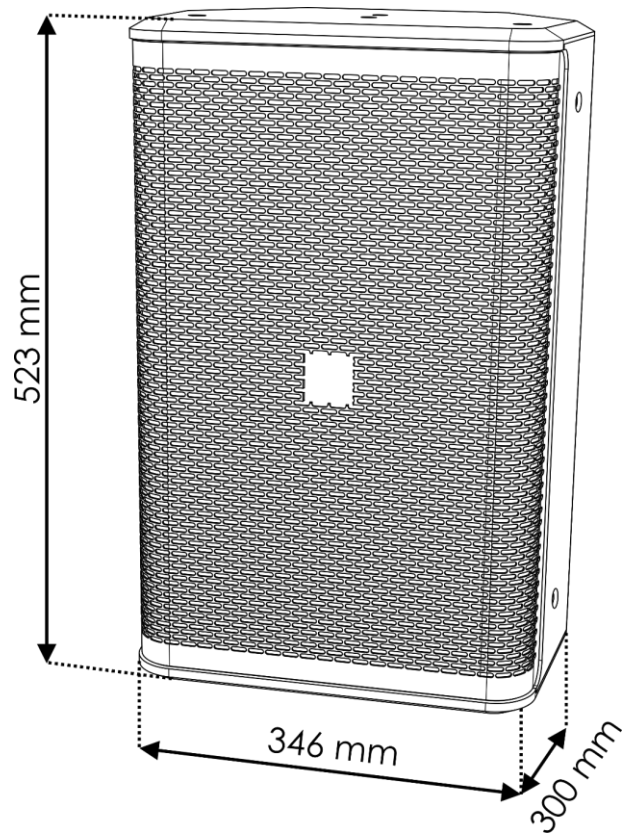

D3546/D3547 - Xi-10











©2021 DAP Audio